

SUPPLEMENT

TO THE

NEW ZEALAND GAZETTE

OF

THURSDAY, JANUARY 26, 1905.

Published by Authority.

WELLINGTON, THURSDAY, JANUARY 26, 1905.

CONTENTS.

	Page
Official Notices .. .. .	201
Patent Agent registered .. .. .	202
Complete Specifications accepted .. .. .	202
Provisional Specifications accepted .. .. .	205
Letters Patent sealed .. .. .	205
Letters Patent on which Fees have been paid .. .. .	206
Subsequent Proprietors of Letters Patent registered .. .. .	206
Applications for Letters Patent abandoned .. .. .	206
Applications for Letters Patent void .. .. .	206
Applications for Letters Patent lapsed .. .. .	206
Letters Patent void .. .. .	206
Applications for Registration of Trade Marks .. .. .	207
Trade Marks registered .. .. .	211
Trade Mark Renewal Fees paid .. .. .	211
Subsequent Proprietors of Trade Marks registered .. .. .	211
Quarterly List of Inventors* .. .. .	212
Quarterly List of Inventions* .. .. .	221
Quarterly List of Trade Marks Applicants* .. .. .	232
Quarterly List of Designs Applicants* .. .. .	235
Illustrations of Inventions.	

\* Alphabetical lists for the preceding quarters of the year 1904 appear in *Gazette* No. 31, of the 14th April, 1904; *Gazette* No. 62, of the 21st July, 1904; and *Gazette* No. 83, of the 13th October, 1904.

Official Notices.

LIBRARY.

THE library attached to the Patent Office is open free to the public during office hours. It contains, amongst others, the following publications:—

United Kingdom.

- Specifications and drawings of inventions accepted up to 8th September, 1904.
- Classified abridgment of inventions to 1900.
- Illustrated Official Journal to October, 1904.
- Trade Marks Journal to July, 1904.

Canada.

Patent Office Record (containing illustrated abridgments of inventions) to May, 1904.\*

\* These may be seen also at the public libraries, Auckland and Christchurch.

Australian Commonwealth.

The Official *Gazette*, containing lists of applications for letters patent, &c.

The *Gazettes* of the various States, containing lists of trade marks applied for, &c.

United States.

The Official *Gazette* (containing illustrated abridgments of inventions, &c.) to October, 1904.\*

OFFICIAL PUBLICATIONS.

The following publications may be obtained from the Government Printer, Wellington:—

- Printed specifications to the end of the year 1879.
- Annual lists of letters patents and letters of registration applied for, and particulars of applications lapsed, and patents lapsed, from 1880 to 1888 inclusive.
- Annual reports of the Registrar, containing alphabetical lists of applicants for letters patent and of inventions patented from 1889 to 1903 inclusive.
- The Patents Supplement to *Gazette* (containing notifications, applications for letters patent, abridged descriptions and drawings of inventions, &c.), published fortnightly.

LOCAL PATENT OFFICES.

Local patent offices for the reception of applications for letters patent without extra payment have been appointed at the following places: Ashburton, Auckland, Blenheim, Christchurch, Dunedin, Gisborne, Greymouth, Hokitika, Invercargill, Napier, Nelson, New Plymouth, Oamaru, Queenstown, Thames, Timaru, Wanganui, Westport. These are situated in the Supreme Court Buildings and S.M. Courthouses.

FORMS.

Forms of application and specification for letters patent, with sheet of information concerning fees and procedure, are obtainable without payment at the Patent Office, any local patent office or money-order office.

PATENT AGENTS.

A list of registered patent agents may be obtained on application.

\* May be seen also at the Public Library, Christchurch.

Patent Agent registered.

Patent Office,  
Wellington, 25th January, 1905.

IT is hereby notified that  
JOSEPH RICHARD CLEMENT,  
of Waimate, New Zealand, Barrister and Solicitor, has been registered as a Patent Agent.  
F. WALDEGRAVE,  
Registrar.

*Notice of Acceptance of Complete Specifications.*

Patent Office,  
Wellington, 25th January, 1905.

COMPLETE specifications relating to the undermentioned applications for Letters Patent have been accepted, and are open to public inspection at this office. Any person may, at any time within two months from the date of this *Gazette*, give me notice in writing of opposition to the grant of any such patent. Such notice must set forth the particular grounds of objection, and be in duplicate. A fee of 10s. is payable thereon.

No. 17139.—24th October, 1903.—ROBERT RUTHERFORD DOUGLAS, of Dunedin, New Zealand, Dredgemaster. A protector for the buckets and links of dredge elevators.\*

*Extract from Specification.*—The invention consists in securing a steel plate to the under-side of the link or bucket in order to protect same from wear.

[NOTE.—The above extract from the specification is inserted in place of the claims.]

(Specification, 3s. 3d.; drawing, 1s.)

No. 17660.—16th March, 1904.—UNITED SHOE MACHINERY COMPANY, of Paterson, State of New Jersey, United States of America, a corporation duly organized under the laws of said State of New Jersey, and having a place of business at 205, Lincoln Street, Boston, Massachusetts, United States of America (assignees of Arthur Bates, of Leicester, England, Machinist). Improvements in or relating to heel-attaching machines.\*

*Extract from Specification.*—According to the present invention, there is employed in a heel-attaching machine, for the purpose above described, the combination with a post or other convenient base and a movable work-support upon it, of a nail-driver arranged to drive a nail in a direction away from the work-supporting face of said support into the work supported thereby, and means to adjust the support into and retain it in positions in which this work-supporting face shall be in oblique relation to the path of the driver—that is to say, in such relation that the path of the driver shall not be normal or perpendicular to the plane or surface of that face, but shall have the same obliquity thereto as the nail is to have in relation to the face of the heel-seat lift into which it is to be driven, &c.

[NOTE.—The above extract from the specification is inserted in place of the claims.]

(Specification, £1 13s.; drawings, 5s.)

No. 17681.—21st March, 1904.—SAMUEL GEORGE ROSEMAN, of Grey Lynn, Auckland, New Zealand, Brush-manufacturer. Improvements in the manufacture of brooms or brushes.\*

*Claims.*—(1.) In the manufacture of brooms and brushes, securing the fibre or like material between twisted wires, and then bending such twisted wires so as to form a frame of any desired shape, and securing such frame to a handle, substantially as specified. (2.) In the manufacture of brooms and brushes, securing the fibre or like material between twisted wires, bending such twisted wires so as to form a frame of any desired shape, and securing the ends of the wires within a socket-piece secured to the end of a handle, substantially as specified.

(Specification, 3s.; drawing, 1s.)

No. 17710.—30th March, 1904.—CHARLES EDWARD WARDEN, of 104, Salisbury Street, Christchurch, New Zealand, Contractor. Improvement in or relating to hoops, pegs, and the like, used in parlour games.\*

*Claims.*—(1.) A hoop, peg, or the like, constructed, arranged, and operating substantially as and for the purposes specified, and illustrated in the drawing. (2.) For the pur-

pose indicated, a hoop, peg, or the like, having feet projecting in opposite directions in a plane at right angles to the hoop, substantially as specified and illustrated.  
(Specification, 2s.; drawing, 2s.)

No. 17729.—30th March, 1904.—ROBERT RUTHERFORD DOUGLAS, of 91, Harbour Terrace, Dunedin, New Zealand, Engineer. A combined roller-protector for dredge ladders, elevators, and suchlike.\*

*Claims.*—(1.) The general construction, arrangement, and combination of parts composing my combined roller-protector for dredge ladders, elevators, and suchlike, all substantially as and for the purposes described. (2.) Protector for the rollers of dredge ladders, elevators, and the like, consisting of the combination with a tapered roller of a correspondingly tapered liner provided with a circular flange at one end and means for securing the flange to the roller, substantially as described. (3.) Protector for the rollers of dredge ladders, elevators, and the like, consisting of the combination with a tapered roller of a correspondingly tapered liner provided with a circular flange and a rim at one end forming a recess adapted to receive a washer provided with a bush embracing the end of the roller-spindle, and means for securing the washer and liner to the roller, substantially as described.  
(Specification, 2s. 6d.; drawing, 1s.)

No. 17797.—18th April, 1904.—JOHN BUCHANAN HAY, and ALBERT JOHN DANIEL, both of Petone, Wellington, New Zealand, Engineers. Improved means for treating the offal of animal carcasses.\*

*Extract from Specification.*—The means devised comprise a long hopper with a narrow opening extending longitudinally in its bottom. Mounted outside the hopper is a shaft to which a number of radial knives are attached. The side of the hopper is provided with slots therein, and the knife-shaft is so mounted in relation thereto that as the shaft revolves the knives will pass into the slots and travel across the space in the bottom of the hopper. Beneath the hopper are mounted a pair of squeezing-rollers adjustable in their distance apart, and mounted on horizontally parallel axes. These rollers are carried in bearings upon a suitable frame at each end, and are provided with means whereby they may be rotated in opposite directions. Beneath the rollers is mounted transversely an endless travelling-table, composed preferably of laths of metal linked together. This table is arranged at an incline, and its lower end is placed beneath the point of engagement of the squeezing-rollers. The top end of the table extends upwards over a narrow water trough or tank, in which is mounted a similar endless travelling-table, also arranged to travel in an upwardly inclined direction, and projecting out above one end of the tank.

[NOTE.—The above extract from the specification is inserted in place of the claims.]

(Specification, 6s.; drawings, 2s.)

No. 17927.—17th May, 1904.—FRANK DOVALOSKY, of Leet Street, Invercargill, New Zealand, Coal-miner. Improved hair-pin.\*

*Claims.*—(1.) A pin support located lengthwise along the centre of and within a spiral pin. (2.) A pin support located lengthwise along the centre of and within a spiral pin having its free end or point to extend beyond the penetrating point of the spiral. (3.) Said pin support as located in combination with the spiral having a spherically shaped head fixed to the shank, substantially as described in the specifications and shown in the plans.

(Specification, 1s. 9d.; drawing, 1s.)

No. 18105.—28th June, 1904.—FRANK DOVALOSKY, of Invercargill, New Zealand, Coal-miner. Improved hair-pin.\*

*Claims.*—(1.) A spiral having a straight pin support located within it, same extending beyond penetrating point of spiral, a shank thereon, in combination with a cap to engage said shank and to revolve. (2.) A spiral having a pin support within it, point of same extending beyond penetrating point of spiral, shank thereon, in combination with an inverted U-shaped cap to engage said shank and to revolve, substantially as described in the specification and shown in the plans.

(Specification, 1s. 9d.; drawing, 1s.)

No. 18483.—22nd September, 1904.—HENRY DOWLING, of Frederick Street, Camperdown, near Sydney, New South Wales, Australia, Mariner, and EDWIN DAVID JAMES BALFOUR, of 22, Ann Street, Balmain, near Sydney aforesaid, Master Mariner. Improvements in electric belts.

*Extract from Specification.*—With the electric belt which forms the subject of the present application a constant cell or battery is employed, the current from which passes through an induction-coil, and from thence to two pairs of electrodes or flesh-discs, one pair being in front of the belt and the other pair at the rear of the belt. The two flesh-discs in each pair are supplied with an electric current of one denomination, either + or -, and the other pair with electricity of the opposite denomination, either + or -, as the case may be, from the other pair. The conducting wires that convey the current from the coil enter the belt about midway between the two pairs of electrodes, and intermediately between the point of entrance of the wires and the electrodes provision is made whereby the wire may be temporarily broken, and an extension attachment be connected, whereby the current may be conveyed to one or more of the several extremities of the body.

[NOTE.—The above extract from the specification is inserted in place of the claims.]

(Specification, 3s. 6d.; drawing, 1s.)

No. 18554.—6th October, 1904.—HERBERT JAMES BAKER, of 135, Barbadoes Street, Christchurch, New Zealand, Commission Agent. An improved churn.\*

*Claims.*—(1.) For the purpose indicated, a vessel provided with vertical ribs upon its inner periphery, the faces of said ribs having projections and recesses, a beater within said vessel the edges of which are also shaped with projections and recesses, with means for revolving said beater, substantially as specified. (2.) For the purpose indicated, in combination, a vessel provided with vertical ribs upon its inner periphery, the faces of said ribs having projections and recesses, a beater within said vessel the edges of which are also shaped with projections and recesses, a spindle for said beater, a pinion fixed thereon, a spur wheel gearing with said pinion, a handle for revolving same, and a bracket carrying said spindle, with means for removably attaching said bracket to said vessel, as specified. (3.) For the purpose indicated, the improved churn consisting of the parts arranged, combined, and operating substantially as specified, and as illustrated in the drawing.

(Specification, 2s. 6d.; drawings, 2s.)

No. 18630.—20th October, 1904.—EDWIN PHILLIPS, of 533, Collins Street, Melbourne, Victoria, Australia, Patent Attorney and Engineer (nominee of Charles Maus Taylor, of Bourse Building, Philadelphia, Pennsylvania, United States of America, Inventor). Improved cream-products, and apparatus for making the same.

*Claims.*—(1.) A product derived from cream by placing the latter in contact with absorbent material permeable by its fluid and impermeable by its solid constituents whereby the fatty globules of the cream with their adhering particles of casein and the like are retained unbroken and unaltered and the fluid constituents are removed. (2.) A substitute for cream consisting of the product described above diffused in water, milk, or other suitable fluid medium. (3.) An apparatus for treating cream comprising a partition impermeable by the fatty constituents and permeable by the other constituents thereof, a receptacle to hold the same, a non-absorbent spacer to support the partition, and means for receiving the excess of constituents permeable through the partition. (4.) An apparatus for treating cream comprising a partition impermeable by the fatty constituents and permeable by the other constituents thereof, a receptacle to hold the same, means for supporting the partition, means, as a vacuum pump, for creating a less pressure on the drainage side of the partition to facilitate the operation, and means for collecting the excess of constituents permeable through the partition, with or without means for excluding the outer air from the apparatus during the operation. (5.) A centrifugal machine inclosed in a vacuum chamber, the basket of the machine being provided with walls comprising material impermeable by the fatty constituents of cream and permeable by its other constituents, means for suitably sealing the chamber against the air, and means for supplying cream to the basket of the machine without allowing the same to come into contact with the outer air.

(Specification, 6s. 3d.; drawings, 2s.)

No. 18636.—19th October, 1904.—CHARLES EDMUND DENMEAD, Plumber, and FRANCIS JOSEPH MAHONEY, Commercial Traveller, both of Christchurch, New Zealand. Improved means for jointing the trap of a water closet, stop-hopper, and suchlike devices to the soil or lead way pipe.

*Claims.*—(1.) For the purpose specified, a faucet-shaped stout casting, into the larger end of which the end of the trap-pipe of closet-basins, stop-hoppers, or the like, will come, said end being large enough to admit the trap-pipe end, and permit of rope-yarn being tamped down around said pipe-end and hot bitumen poured upon the rope-yarn, the lower part of the casting being reduced so as to adapt it to come into the soil-pipe and be jointed therein, substantially as described. (2.) A faucet-shaped stout casting that is employed to replace a short length of lead piping in the manner and for the purposes specified.

(Specification, 1s. 9d.; drawing, 1s.)

No. 18698.—3rd November, 1904.—DANVILL WILLIAM STARRETT, of 121, Mission Street, San Francisco, California, United States of America, Engineer. Improvements in compressed-air pumps.

*Claim.*—The compressed-air pump for pumping water up a pipe whose height exceeds that of a solid column of water balancing the compressed-air pressure, having the branch pipe from the compressed-air pipe to the water-discharge pipe above and near to the check-valve in the latter, said branch pipe having an opening sufficiently large to distribute the air through the water in the discharge-pipe so that the weight of the latter does not overbalance the compressed-air pressure, substantially as described.

(Specification, 2s. 6d.; drawing, 2s.)

No. 18707.—7th November, 1904.—JAMES THOMAS HUNTER, of Queen's Chambers, Wellington, New Zealand, Registered Patent Agent (nominee of Thomas Rouse, of 7, Old Hill Street, Stamford Hill, London, N.E., England, Gentleman, and Herrmann Cohn, of 7, Brunswick Square, St. Pancras, London, W.C., England, Merchants). Improved method of converting into briquettes or lumps iron-ore, whether natural or prepared by reducing to powder iron-ore or iron-wastes.\*

*Claims.*—(1.) The process of agglomerating into briquettes or lumps by means of a weak solution of alum powdered iron-ore or iron-wastes, or natural iron-sands, or mixtures thereof, for hardening the same by exposure to the atmosphere or otherwise, substantially as described. (2.) The process of agglomerating into briquettes or lumps by means of a weak solution of alum powdered iron-ore or iron-wastes, or natural iron-sands, or mixtures thereof, and hardening the said briquettes or lumps by exposure to a high temperature, substantially as described.

(Specification, 1s. 6d.)

No. 18710.—2nd November, 1904.—ROBERT LOUIS HOWELL MURRAY, of 193, Karangahape Road, Auckland, New Zealand, Electrician. Improvements in acetylene-gas generators.

*Claims.*—(1.) The general construction of the water-supply pipe, in combination with an independent gas-conduct pipe, being in one piece of mechanism, thus avoiding the necessity of making two or more joints in generating-chamber, and preventing any interference with the free exit of gas into the gas-holder from any other generating-chamber of acetylene-gas generators. (2.) The continuation of the safety pipe from the top of the gas-holder through a suitable support up to any height desired into the open air. (3.) A weighted rod operating a sliding bar with spring, in combination with a levered valve regulating the supply of water to the generating-chambers, as substantially described in specification, and illustrated in drawings.

(Specification, 3s. 6d.; drawing, 1s.)

No. 18853.—13th December, 1904.—CHARLES JOSEPH ALEXANDER, of 60A, Wilson Street, Finsbury, London, Great Britain, Manager and Merchant. Improvements in incandescent gas-burners.

*Extract from Specification.*—According to the invention, the lower end of the outer telescopic gas-and-air supply tube carrying the burner-head is provided with a supplementary mixing-chamber, preferably dome-shaped, the bottom of which chamber is provided with a central opening through which

passes and fits the corrugated inner telescopic gas-and-air supply tube. The bottom of the chamber may also be provided with apertures for an auxiliary supply of air.

[NOTE.—The above extract from the specification is inserted in place of the claims.]

(Specification, 3s.; drawing, 1s.)

No. 18855.—14th December, 1904.—ARTHUR GEORGE RICH WILLIAMS, of "Rothsay," William Street, Cambridge, Wai-kato, Auckland, New Zealand, Engineer. Improved basting-apparatus.

*Claims.*—(1.) Apparatus for the purpose indicated, comprising, in combination, a baking-dish, a well upon the bottom thereof, a tube projecting down into said well, the lower end of said tube conical, a nozzle upon the upper end of said tube, and means of supporting said tube with its lower conical end above the bottom of the well, substantially as specified. (2.) Apparatus for the purpose indicated, comprising, in combination, a baking-dish, a well upon the bottom thereof, a tube projecting downwardly into said well, the lower end of said tube conical, a nozzle upon the upper end of the tube, a perforated ring surrounding the tube, and arms connecting the ring with the tube, said ring being received by a recess in the bottom of the baking-dish, substantially as specified. (3.) Apparatus for the purpose indicated, comprising, in combination, a baking-dish, a tubular well closed at its lower end and having a flange upon its upper end, said flange fitting a recess in the bottom of the baking-dish, a back nut screwing upon the well, a tube having a conical lower end, a nozzle upon the upper end of said tube, a ring surrounding the tube, and arms connecting the tube with the ring, said ring being perforated and adapted to fit a recess in the well and being so arranged in relation to the tube that the tube is supported with its lower end above the bottom of the well, substantially as specified and illustrated. (Specification, 3s.; drawing, 1s.)

No. 18861.—13th December, 1904.—THE LAMP-MANUFACTURING COMPANY, LIMITED, of 10-14, Leonard Street, City Road, London, England, Manufacturers (assignees of William Henry Isaac Welch, of 33, Liebfeld Road, Bow, London, England, Gas Engineer). Improvements in oil-lamps for railway signals and other purposes.

*Extract from Specification.*—"To effect these objects the burner is designed to give a small flame, and the light therefrom is directed by specially shaped and disposed lenses in the required direction or directions, the air for combustion being led into the interior of the lamp in such manner that it is distributed therein without directly impinging on the flame, thereby enabling a small flame to be used. An auxiliary wick, which may lead to the oil-reservoir or may derive oil from the burner-wick, is coiled around the upper perforated part of the burner-tube, and serves to keep the wick cool and prevent or retard charring, and also, acting as a storage chamber, continues to provide oil for combustion when the burner-wick is unable, on account of charring, to supply the oil required to maintain the light."

[NOTE.—The above extract from the specification is inserted in place of the claims.]

(Specification, 4s.; drawing, 1s.)

No. 18885.—22nd December, 1904.—EDWIN RICHARD SMITH, of 50, Broadway, Buffalo, New York, United States of America, Manufacturer. Improvements in shaft-bearings.

*Claims.*—(1.) In a shaft-bearing, the combination with a support and an upright shaft, of an adjustable stop mounted on the shaft above said support, a bearing surrounding the shaft between said support and said adjustable stop, and including rolling anti-friction members, whereby the shaft is sustained by said bearing, and a lifting-device independent of said bearing acting on the shaft, whereby the shaft with its stop can be raised independently of said bearing and the stop then lowered to rest upon the bearing and support the shaft. (2.) In a shaft-bearing, the combination with a support and an upright shaft, of bearing-discs loosely surrounding said shaft, the lower disc being sustained by said support, rolling anti-friction members interposed between said discs, a stop-collar adjustably secured to the shaft and resting upon the upper bearing-disc, and a lifting-device independent of said bearing-members acting on the lower end of the shaft. (3.) In a shaft-bearing, the combination with a support and a depending socket located on the under-side thereof, of an upright shaft passing through said support and having its lower end arranged in said socket, bearing-discs loosely surrounding said shaft, the lower disc being sustained by said support, rolling anti-friction members interposed between

said discs, a collar adjustably secured to the shaft and resting upon the upper bearing-disc, and a lifting-screw independent of said bearing-members passing through the bottom of said socket and acting on the lower end of the shaft. (Specification, 4s.; drawing, 1s.)

No. 18893.—24th December, 1904.—ARTHUR EDWARD GILL, of Redwood's Valley, Nelson, New Zealand. Improved clamp for wire rope.

*Claim.*—For the purpose indicated, in combination, a clamp comprising two metal plates recessed to receive the two parts of the wire rope, and a bolt passing through said plates for the purpose of drawing them together, substantially as specified and illustrated.

(Specification, 1s.; drawing, 1s.)

No. 18903.—29th December, 1904.—JAMES BENJAMIN MCCUBBIN, of No. 99, Scotchmere Street, North Fitzroy, Victoria, Australia, Police Constable. Improvements in reversible heels for boots and shoes.

*Claims.*—(1.) In reversible heels for boots and shoes, the combination with the bottom plate C, of the annular plate F, the projections a, b, c, and d thereon, spring G, and locking-pin H, substantially as described and explained, and as illustrated in the drawings. (2.) In reversible heels for boots and shoes, the combination with the top plate K, having the hole N, of the pad L attached thereto, substantially as described and explained, and as illustrated in the drawings. (3.) In reversible heels for boots and shoes, the combination with the bottom plate C, annular plate F, and projections a, b, c, and d thereon, spring G, and locking-pin H, of the top plate K, having the hole N therein, and pad L attached thereto, substantially as described and explained, and as illustrated in the drawings.

(Specification, 4s. 6d.; drawing, 1s.)

No. 18906.—29th December, 1904.—RODERICK MCKENZIE McLENNAN, of Littlebourne, Dunedin, New Zealand, Shipping Clerk. Improvements in calendars.

*Extract from Specification.*—There is an arrangement whereby the calendar for any year past or to come may be obtained by the manipulation of a sliding plate carrying day numbers arranged in a particular way behind apertures arranged also in a particular way, combined with the use of the well-known dominical letters. For the purpose of arriving at the dominical letter for the year required, the years are arranged in columns under the dominical letter to which they belong after calculation in the ordinary way, with a special provision for leap year by repeating such year in two successive columns. There is a universal time indicator, which may be used in combination with this calendar, consisting of clock markings round a circular opening behind which a circular piece rotates. This circular piece is graduated on its rim for longitude, and has an index hand or pointer fixed thereto or drawn thereon on the longitude of the place where the calendar is to be used. Consequently when this index hand is set to the time of such place the corresponding time of any place of which the longitude is known can be ascertained by inspection. Combined with the two previously described arrangements may be a day calendar of any suitable type adapted to show day, month, and date, and a timepiece may also be combined therewith.

[NOTE.—The above extract from the specification is inserted in place of the claims.]

(Specification, 12s.; drawing, 7s.)

No. 18910.—31st December, 1904.—ARCHIBALD LOWE, of Mahora, Hastings, Hawke's Bay, New Zealand, Farmer. Improved thinning and weeding knife.

*Claims.*—(1.) A device for the purpose indicated, constructed and arranged substantially as specified and illustrated. (2.) A thinning and weeding knife having a shank bent at right angles to the handle, parallel sides with sharpened edges, and a tapering point projecting longitudinally from one side, substantially as specified.

(Specification, 1s. 3d.; drawing, 1s.)

**ERRATUM.**—No. 18830. W. T. London, plant-pot (advertised in Supplement to *New Zealand Gazette*, No. 3, of 12th January, 1905).—The words "having one end smaller than the other" were inadvertently omitted from the claim after the words "comprising in combination a band."

An asterisk (\*) denotes the complete specification of an invention for which a provisional specification has been already lodged.

NOTE.—The cost of copying the specification and drawing has been inserted after the notice of each application. An order for a copy or copies should be accompanied by a post-office order or postal note for the cost of copying.

The date of acceptance of each application is given after the number.

Extracts from the drawings accompanying the foregoing complete specifications appear at the end of this *Gazette*.

F. WALDEGRAVE,  
Registrar.

*Provisional Specifications.*

Patent Office,  
Wellington, 25th January, 1905.

APPLICATIONS for Letters Patent, with provisional specifications, have been accepted as under:—

No. 18707.—7th November, 1904.—JAMES THOMAS HUNTER, of Queen's Chambers, Wellington, New Zealand, Registered Patent Agent (nominee of Thomas Rouse, of 7, Old Hill Street, Stamford Hill, London, N.E., England, Gentleman, and Herrmann Cohn, of 7, Brunswick Square, St. Pancras, London, W.C., England, Merchant). Improved method of converting into briquettes or lumps iron-ore, whether natural or prepared by reducing to powder iron-ore or iron-wastes.

No. 18877.—20th December, 1904.—DAVID JOSEPH WILLIAMS, of Waimangaroa Junction, Nelson, New Zealand, Flax-miller. Improved apparatus for conveying flax from strippers and cleaning the same.

No. 18881.—19th December, 1904.—ALEXANDER HENRY KRAUSE, of Grey Lynn, Auckland, New Zealand, Manufacturer. Improvements in and relating to machine-made boxes.

No. 18882.—19th December, 1904.—ALEXANDER HENRY KRAUSE, of Alderley, Mackelvie Street, Grey Lynn, Auckland, New Zealand, Manufacturer. An improved, adjustable, collapsible, and folding deck-chair, with hood and neck-rest attached.

No. 18911.—5th January, 1905.—JAMES ROSS, of Dannevirke, New Zealand, Blacksmith. An improved screw wedge.

No. 18917.—31st December, 1904.—CHARLES SUTTIE, Engineer, and MONTAGUE HARRISON WYNYARD, Solicitor, both of Onehunga, Auckland, New Zealand. An improved apparatus for treating New Zealand flax after stripping.

No. 18919.—6th January, 1905.—FRANCIS GEORGE HARRY WHITE, of 5, East Street, Newton, Auckland, New Zealand, Mariner. Improved rigging-screw.

No. 18921.—4th January, 1905.—HARRY KITCHIN, of 9, Park Road, Middle Park, near Melbourne, Victoria, Australia, Mechanical Engineer. Improved undergear for go-carts and the like.

No. 18922.—4th January, 1905.—FRANK VICTOR RAYMOND, of Invercargill, New Zealand, Solicitor. Improvements in dish-racks.

No. 18925.—9th January, 1905.—UNITED SHOE MACHINERY COMPANY, of Paterson, State of New Jersey, United States of America, a corporation duly organized under the laws of said State of New Jersey, and having a place of business at 205, Lincoln Street, Boston, Massachusetts, United States of America (assignees of Marshall Henry Pearson and Arthur Ernest Jerram, both of Union Works, Belgrave Road, Leicester, England, Engineers). Improvements in or relating to apparatus for arranging and delivering eyelets or rivets or other articles of like form.

No. 18926.—9th January, 1905.—UNITED SHOE MACHINERY COMPANY, of Paterson, State of New Jersey, United States of America, a corporation duly organized under the laws of said State of New Jersey, and having a place of business at 205, Lincoln Street, Boston, Massachusetts, United States of America (assignees of Frederick Henry Perry, of West Medford, Middlesex, Massachusetts aforesaid, Inventor). Improvements in or relating to fastening-machines.

No. 18927.—9th January, 1905.—CHARLES EDWARD LOWE, of Motueka, New Zealand, Manager. A machine for cleaning and for stripping currants and the like from their stalks.

No. 18928.—9th January, 1905.—JOHN JOSEPH HEALY, of 12, Clifton Street, Richmond, Victoria, Australia, Agent. An improved cooler for cream and other liquids.

No. 18929.—7th January, 1905.—WILLIAM DALL, of Dunedin, New Zealand, Merchant. Improved bowl- or ball-testing machine.

No. 18930.—7th January, 1905.—JAMES THOMSON and GEORGE GEORGESEN, both of Princes Street, North Invercargill, New Zealand, Carpenters. Improvements in and relating to fastenings for brooches and the like.

No. 18931.—10th January, 1905.—HENRY CHARLES CIANTAR, Engineer, and UMBERTO CIANTAR, Merchant, both of 9 and 10, Great Tower Street, London, England. Improvements in extracting gold from solution in water.

No. 18935.—10th January, 1905.—HENRY EDWIN McDONALD, of Petone, New Zealand, Merchant. A revolving egg-preserver.

No. 18936.—10th January, 1905.—HENRY EDWIN McDONALD, of Petone, New Zealand, Merchant. An improved case for the safe carriage of eggs.

No. 18938.—11th January, 1905.—MICHAEL DOUGLAS TAYLOR, of Fort Street, Auckland New Zealand, Tea-merchant. Improvement in wheels of motor-cars and the like.

No. 18939.—11th January, 1905.—HENRY ALEXANDER ENGLISH, of General Post-office, Wellington, New Zealand, Civil Servant. Improvements relating to cannons, rifles, or the like, and projectiles therefor.

No. 18940.—11th January, 1905.—GEORGE CARRINGTON, of Clive, Hawke's Bay, New Zealand, Cook. A machine for use in shelling peas.

No. 18941.—11th January, 1905.—GEORGE CARRINGTON, of Clive, Hawke's Bay, New Zealand, Cook. Improvements in or relating to gates.

No. 18942.—9th January, 1905.—JOHN DAVIES, of 21, Grafton Road, Auckland, New Zealand, Steelworker. A fuel-economizing and smoke-consuming furnace.

No. 18944.—10th January, 1905.—ALFRED REGINALD HARDY, of Dunedin, New Zealand, Accountant. Improvements in gates.

No. 18945.—10th January, 1905.—ROBERT WALKER, of Dunedin, New Zealand, Tinsmith. Improvements in milk-cans.

No. 18950.—12th January, 1905.—WILLIAM MCKINNON, of Arapawanui, Hawke's Bay, New Zealand, Station-manager. Apparatus for automatically feeding fowls and animals.

NOTE.—Provisional specifications cannot be inspected, or their contents made known by this office in any way, until the complete specifications in connection therewith have been accepted.

The date of acceptance of each application is given after the number.

F. WALDEGRAVE,  
Registrar.

*Letters Patent sealed.*

LIST of Letters Patent sealed from the 12th to the 25th January, 1905, inclusive:—

- No. 16511.—J. Tolson, incandescent-mantle lighter.
- No. 16927.—J. Mackay and F. W. Hamilton, ambulance lifter.
- No. 16969.—E. Gillow, drawing-board, easel, and T square.
- No. 17017.—J. G. L. Hewitt, filling for roofs (A. Wilson).
- No. 17019.—W. E. Hughes, water-table (J. B. Jackson).
- No. 17105.—L. Clark, flanging sanitary pipes.
- No. 17116.—J. Macalister, chain-drive manure-feed.
- No. 17140.—J. Hair, horse-shoe.
- No. 17157.—T. E. O'Brien, bottle.
- No. 17165.—W. Riddell, tare beam scales.
- No. 17278.—L. Frame, steam-consumer for washing-boiler.
- No. 17288.—C. Cooper, weighing-machine.
- No. 17303.—L. B. Horrocks, vending-machine.
- No. 17322.—W. J. Standen, cutting and tailing lambs.
- No. 17386.—C. E. Gray and J. S. Tolman, franking and stamping machine.
- No. 17388.—T. C. Homent, sheet-metal piping.
- No. 17422.—H. Schnitzer, warming food.
- No. 17453.—United Shoe Machinery Company, buffing-rolls (W. Gordon).
- No. 17465.—B. C. Barton, bedstead.
- No. 17639.—A. Gillies, pneumatic teat-cups.
- No. 17713.—H. S. Wainwright, spark-arrester.
- No. 17714.—H. S. Wainwright, spark-arrester.
- No. 17888.—W. Tarrant, horse-shoe.
- No. 17988.—R. F. Marsh, washing-machine.
- No. 18102.—A. E. and H. G. Bradley, water-pumping apparatus.
- No. 18204.—American Seeding-machine Company, distributor for grain-drill (F. A. Packham and G. P. Oates).
- No. 18205.—W. King, bird-trap.
- No. 18331.—R. Thomas and G. Hall, fencing-post.
- No. 18333.—A. Stephan and R. Sands, half-tone photography.
- No. 18361.—E. C. Mahony, portable wall-sections.
- No. 18369.—J. F. McNeill, gate.
- No. 18386.—J. J. McDade, affixing postage-stamps.
- No. 18390.—S. A. Ekehorn, rotating churn.
- No. 18391.—O. M. J. Olsen and W. Gates, gas-burner regulator.
- No. 18395.—T. Burrell, elastic attachment for soles and heels.
- No. 18406.—C. R. S. J. Hallé, vehicle-wheel.
- No. 18407.—F. Eisenbeis and F. Garelly, coal-cutting and channelling tool.

- No. 18415.—M. Weinrich, drying granular materials.  
 No. 18416.—T. Cook, crozing and chiming machine.  
 No. 18418.—Standard Mouthpiece Machine Company, cigarette-mouthpiece (G. P. Butler).  
 No. 18419.—J. A. Ferguson, mould for building-block.  
 No. 18430.—J. Taylor, wash-board.  
 No. 18464.—C. E. Bernays, vehicle-bogie.  
 No. 18467.—L. Bender, butter-cutter.  
 No. 18478.—G. Koch, shaving-brush.  
 No. 18485.—A. Bridge, cricket-stumps.  
 No. 18492.—J. H. Rowland, game.  
 No. 18500.—W. Hoskins, treating fatty wood.  
 No. 18501.—F. W. Gasmier, railway brake.  
 No. 18503.—W. R. Whitney, filaments.  
 No. 18504.—W. E. Hamilton, mining-machine.  
 No. 18505.—O. Gemeinhardt, measuring and wringing skins.  
 No. 18506.—H. C. Woltereck, producing ammonia.

F. WALDEGRAVE,  
 Registrar.

*Letters Patent on which Fees have been paid.*

[NOTE.—The dates are those of the payments.]

SECOND-TERM FEES.

- No. 13316.—C. S. Snell, gas or air compressor. 10th January, 1905.  
 No. 13318.—J. N. Clapham, rein-holder and wheel-stop. 14th January, 1905.  
 No. 13325.—The Concentrated Beer Company, Limited, production of beer (H. A. Hobson). 13th January, 1905.  
 No. 13331.—J. Jamison, tidal-power motor. 20th January, 1905.  
 No. 13335.—F. F. Church, voting-machine (A. J. Gillespie). 10th January, 1905.  
 No. 13346.—P. Lanigan, stone-cutting machine. 24th January, 1905.  
 No. 13385.—F. G. M. Brittin, gold-saving apparatus (F. G. M. Brittin, O. Magnus, and W. Le Cren). 21st January, 1905.  
 No. 13397.—A. M. Nicholas, rotating filtering-apparatus. 18th January, 1905.  
 No. 13407.—L. I. Blake and L. N. Morscher, separation of conductors from non-conductors. 10th January, 1905.  
 No. 13410.—M. I. Pupin, reducing attenuation of electrical waves. 20th January, 1905.  
 No. 13487.—United Shoe Machinery Company, boot-protector driver (B. F. Mayo). 12th January, 1905.  
 No. 13741.—G. Westinghouse, car-couplings. 10th January, 1905.

THIRD-TERM FEE.

- No. 10300.—P. A. C. Bates, composition for pavements. 12th January, 1905.

F. WALDEGRAVE,  
 Registrar.

*Subsequent Proprietors of Letters Patent registered.*

[NOTE.—The name of the patentee is given in brackets. The date is that of registration.]

No. 16342.—International Harvester Company, a corporation organized under the laws of the State of New Jersey, United States of America, and whose office and place of business is in the City of Chicago, Cook County, State of Illinois, United States of America. Twine. [W. Deering.] 16th January, 1905.

The New Zealand Mitre-machine Company, Limited, a company incorporated in New Zealand under "The Companies Act, 1882," and its amendments, and having its registered office at High Street, Dunedin, New Zealand—

No. 16654.—Holding packing for circular saws. [R. Wales].

No. 16662.—Bar and stop for mitre-cutter. [R. Dunne.] 16th January, 1905.

No. 18290.—The British Westinghouse Electric and Manufacturing Company, Limited, of Westinghouse Building, Norfolk Street, in the City of Westminster, England, Manufacturers. Electric-motor controller. [J. T. Hunter—G. Laird and J. P. Todd.] 16th January, 1905.

F. WALDEGRAVE,  
 Registrar.

*Applications for Letters Patent abandoned.*

LIST of applications for Letters Patent, with which provisional specifications only have been filed, abandoned (i.e., complete specifications not lodged) from the 12th to the 25th January, 1905, inclusive:—

- No. 17650.—K. Davy, mechanical toy.  
 No. 17651.—H. D. Manning, securing cover of nightsoil-pan.

- No. 17652.—S. H. Day, spring handle for bucket.  
 No. 17655.—C. V. Jenkins, blindfolding horse.  
 No. 17659.—W. Lee and C. T. Swanell, steam trap water-interceptor.  
 No. 17668.—G. Henderson, jun., solution for killing weeds.  
 No. 17669.—F. J. Farrell, telephone attachment for fire-alarm.  
 No. 17670.—K. Hiendlmayr, tide-motor.  
 No. 17671.—E. Hayes, standard jack.  
 No. 17673.—T. O. Jenkins and W. T. Mack, milking-appliance. (W. Jardine).  
 No. 17674.—A. J. Hutchinson, cylinder for gramophone.  
 No. 17677.—R. Brown and A. Blair, piston-packing.  
 No. 17678.—R. W. Harvey, preserving timber.  
 No. 17680.—W. H. Bowick, stove-polish.  
 No. 17682.—F. Hitchcock, ventilator.  
 No. 17686.—W. C. Gee, planing-machine.  
 No. 17688.—C. F. Lungley, treating ironsand.  
 No. 17691.—J. Pomeroy, axe head and handle.  
 No. 17692.—E. L. Baggstrom, stair-rod.  
 No. 17693.—M. Browne, handle and stand for clothes-iron.  
 No. 17694.—F. J. Single, horse-shoe.  
 No. 17699.—D. J. Williams, flax conveyor and cleaner.  
 No. 17700.—J. M. Harding, water-tube furnace.  
 No. 17705.—J. W. Andrew, sprayer.

F. WALDEGRAVE,  
 Registrar.

*Applications for Letters Patent void.*

APPLICATIONS for Letters Patent, with which complete specifications have been lodged, void owing to non-acceptance of such complete specifications, from the 12th to the 25th January, 1905, inclusive:—

Nil.

F. WALDEGRAVE,  
 Registrar.

*Applications for Letters Patent lapsed.*

LIST of applications lapsed owing to Letters Patent not being sealed, from the 12th to the 25th January, 1905, inclusive:—

- No. 16633. J. Walsh, hedge-clipping tool.  
 No. 16635.—C. G. Gamble, wire winder and unwinder.  
 No. 16659.—E. V. Sanderson and H. Mackay, siphon.  
 No. 16664.—J. Volkner, spark-arrester.  
 No. 16707.—P. Irwin, lifting and depositing soil.

F. WALDEGRAVE,  
 Registrar.

*Letters Patent void.*

LETTERS Patent void through non-payment of renewal fees from the 12th to the 25th January, 1905, inclusive:—

THROUGH NON-PAYMENT OF SECOND-TERM FEES.

- No. 13060.—F. G. Hughes, cartridge-belt (J. Hylard).  
 No. 13061.—Electric Lighting Boards, Limited, electric glow-lamp (J. A. Halford).  
 No. 13070.—J. Quinn, J. H. Turland, and W. G. Archer, sen., stripper and harvester.  
 No. 13071.—J. Robertson, furniture.  
 No. 13073.—A. F. Thompson, mail-bag sealing buckle.  
 No. 13080.—J. S. Maxwell, silt-punt.  
 No. 13081.—A. G. Thompson, harness saddle.  
 No. 13084.—H. Mayr, sash and frame.  
 No. 13088.—J. Burns, pump.

THROUGH NON-PAYMENT OF THIRD-TERM FEES.

- No. 10014.—J. M. Ewen, prismatic window-plates (O. H. Basquin and W. H. Winslow).  
 No. 10016.—J. M. Ewen, prismatic window lights and plates (O. H. Basquin).  
 No. 10017.—J. M. Ewen, prismatic canopies for windows (O. H. Basquin).  
 No. 10018.—J. M. Ewen, combining ornamental and prism lights and plates for windows (H. F. Belcher).  
 No. 10032.—The Patent Agglomeration Fuel Syndicate, Limited, artificial fuel (H. C. B. Forester).  
 No. 10037.—H. W. Chalmers, incandescent burner.  
 No. 10052.—J. L. Kirkbride, feeder for stamp-battery.

F. WALDEGRAVE,  
 Registrar.

Applications for Registration of Trade Marks.

Patent Office,  
Wellington, 25th January, 1905.

APPLICATIONS for registration of the following trade marks have been received. Notice of opposition to the registration of any of these applications may be lodged at this office within two months of the date of this Gazette. Such notice must be in duplicate, and accompanied by a fee of £1.

No. of application: 5047.  
Date: 1st December, 1904.

TRADE MARK.



NAME.

THE STANDARD PAINT COMPANY, of 100, William Street, New York, United States of America.

No. of class: 50.  
Description of goods: Sheathing and insulating papers.

No. of application: 5048.  
Date: 1st December, 1904.

TRADE MARK.

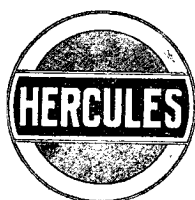

NAME.

THE STANDARD PAINT COMPANY, of 100, William Street, New York, United States of America.

No. of class: 50.  
Description of goods: Sheathing and insulating papers.

No. of application: 5083.  
Date: 19th December, 1904.

TRADE MARK.

THE  
ORPHANS' BENEFIT  
TEA.

The essential particulars of this trade mark are the words "Orphans' Benefit"; and any right to the exclusive use of the added matter is disclaimed.

NAME.

ELLEN DALLY, of Queen Street, Masterton, New Zealand.

No. of class: 42.  
Description of goods: Tea.

No. of application: 5096.  
Date: 10th January, 1905.

TRADE MARK.

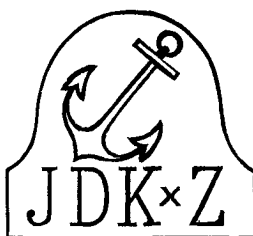

NAME.

JOHN DE KUYPER AND SON, of Rotterdam, Holland, Distillers.

No. of class: 43.  
Description of goods: Geneva.

No. of application: 5097.  
Date: 12th January, 1905.

TRADE MARK.

The word

VILLA

NAME.

LEVER BROS., LIMITED, of Balmain, State of New South Wales, Manufacturers.

No. of class: 47.  
Description of goods: Common soap, soap-powders, candles, matches, starch, blue, washing-soda, detergents, and oil for illuminating, heating, or lubricating purposes.

No. of application: 5098.  
Date: 12th January, 1905.

TRADE MARK.

The word

VILLA.

## NAME.

LEVER BROS., LIMITED, of Balmain, State of New South Wales, Manufacturers.

No. of class : 48.

Description of goods : Perfumed soap, perfumery, and glycerine for toilet purposes.

No. of application : 5099.

Date : 12th January, 1905.

## TRADE MARK.

The word

**DIVAN**

## NAME.

LEVER BROS., LIMITED, of Balmain, State of New South Wales, Manufacturers.

No. of class : 47.

Description of goods : Common soap, soap-powders, candles, matches, starch, blue, washing-soda, detergents, and oil for illuminating, heating, or lubricating purposes.

No. of application : 5100.

Date : 12th January, 1905.

## TRADE MARK.

The word

**DIVAN.**

## NAME.

LEVER BROS., LIMITED, of Balmain, State of New South Wales, Manufacturers.

No. of class : 48.

Description of goods : Perfumed soap, perfumery, and glycerine for toilet purposes.

No. of application : 5104.

Date : 12th January, 1905.

## TRADE MARK.

**R**

The applicants claim that the said trade mark has been used by them and their predecessors in business, Messrs. Engert and Rolfe, in respect of the articles mentioned, for at least one year prior to the 1st January, 1890.

## NAME.

ENGERT AND ROLFE, LIMITED, of Felt-works, Barchester Street, Poplar, London, E., England, Felt-manufacturers.

No. of class : 50.

Description of goods : Roofing-felt.

No. of application : 5105.

Date : 12th January, 1905.

## TRADE MARK.



**"IVANHOE"**

DICKSON BROS & Co  
SHEFFIELD

The applicants claim that the said trade mark has been used by them and their predecessors in business since the 7th June, 1880.

## NAME.

HENRY ROSSELL AND Co., LIMITED, of Waverley Works, Sheffield, England, Steel, File, and Tool Manufacturers, trading as "Dickson Bros. and Co."

No. of class : 5.

Description of goods : Unwrought and partly wrought metals used in manufacture.

No. of application : 5106.

Date : 12th January, 1905.

## TRADE MARK.

(The mark as shown in the preceding notice, No. 5105.)

The applicants claim that the said trade mark has been used by them and their predecessors in business since the 7th June, 1880.

## NAME.

HENRY ROSSELL AND Co., LIMITED, of Waverley Works, Sheffield, England, Steel, File, and Tool Manufacturers, trading as "Dickson Bros. and Co."

No. of class : 12.

Description of goods : Cutlery and edge-tools, including files and saws.

No. of application : 5108.

Date : 12th January, 1905.

## TRADE MARK.



**VICTORY.**

The applicants claim that the said trade mark has been used by them and their predecessors in business since upwards of fifty-five years last past.

## NAME.

HENRY ROSSELL AND Co., LIMITED, of Waverley Works, Sheffield, England, Steel, File, and Tool Manufacturers.

No. of class : 12.

Description of goods : Cutlery and edge-tools, including files and saws.



No. of application : 5109.  
Date : 12th January, 1905.

TRADE MARK.



The applicants claim that the said trade mark has been used by them in respect of the articles mentioned for some years before the 2nd day of September, 1889.

NAME.

HENRY CLAY, AND BOCK AND CO., LIMITED, of London, England, and of Havana, in the Island of Cuba, Cigar-manufacturers, a company registered in London aforesaid.

No. of class : 45.  
Description of goods : Cigars.

No. of application : 5110.  
Date : 13th January, 1905.

TRADE MARK.

The word

**PANIL**

NAME.

THE EVER-FRESH BREAD COMPANY, LIMITED, of 24-26, Holborn, in the City of London, England, Bread-manufacturers.

No. of class : 42.  
Description of goods : Food-stuffs, such as bread, cake, and other baked goods of a similar description.

No. of application : 5111.  
Date : 13th January, 1905.

TRADE MARK.



TRADE MARK

The essential particular of this trade mark is the device; and any right to the exclusive use of the added matter is disclaimed.

NAME.

THE IMPERIAL DRY PLATE COMPANY, LIMITED, of Cricklewood, London, N.W., England, Manufacturers of Photographic Dry Plates, Papers, &c.

No. of class : 1.  
Description of goods : Photographic sensitive plates and photographic sensitive films.

B

No. of application : 5112.  
Date : 13th January, 1905.

TRADE MARK.



TRADE MARK

The essential particular of this trade mark is the device; and any right to the exclusive use of the added matter is disclaimed.

NAME.

THE IMPERIAL DRY PLATE COMPANY, LIMITED, of Cricklewood, London, N.W., England, Manufacturers of Photographic Dry Plates, Papers, &c.

No. of class : 39.  
Description of goods : Photographic sensitive paper.

No. of application : 5113.  
Date : 13th January, 1905.

TRADE MARK.

**PAT-A-CAKE**

NAME.

PEEK, FREAN, AND CO., LIMITED, of 158, Drummond Road, Bermondsey, London, England, Manufacturers.

No. of class : 42.  
Description of goods : Substances used as food, or as ingredients in food.

No. of application : 5115.  
Date : 13th January, 1905.

TRADE MARK.

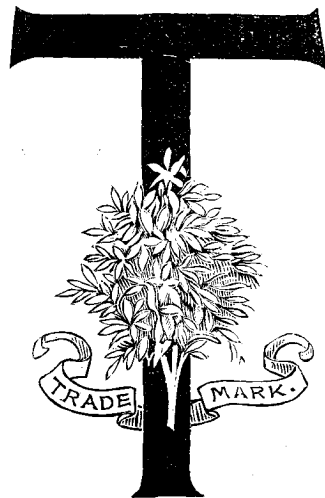

The essential particular of this trade mark is the device; and any right to the exclusive use of the added matter is disclaimed.

## NAME.

R. WILSON AND Co., of Bond and Jetty Streets, Dunedin, New Zealand.

No. of class: 42.  
Description of goods: Tea.

No. of application: 5116.  
Date: 13th January, 1905.

## TRADE MARK.



The essential particular of this trade mark is the device; and any right to the exclusive use of the added matter is disclaimed.

## NAME.

R. WILSON AND Co., of Bond and Jetty Streets, Dunedin, New Zealand.

No. of class: 42.  
Description of goods: Tea.

No. of application: 5117.  
Date: 13th January, 1905.

## TRADE MARK.

The word

“DON.”

## NAME.

R. WILSON AND Co., of Bond and Jetty Streets, Dunedin, New Zealand.

No. of class: 42.  
Description of goods: Tea.

No. of application: 5119.  
Date: 16th January, 1905.

## TRADE MARK.

NEROD

## NAME.

NERNST ELECTRIC LIGHT, LIMITED, AND REDUCED, care of Steuart and Fenn, Limited, of Auckland, New Zealand.

No. of class: 13.  
Description of goods: Electric lamps.

No. of application: 5121.  
Date: 17th January, 1905.

## TRADE MARK.

The word

VOLVOLENE.

## NAME.

ELIZABETH MILSON, of King's Chambers, Wellington, New Zealand, Hair Specialist.

No. of class: 48.  
Description of goods: Toilet preparations.

No. of application: 5122.  
Date: 18th January, 1905.

## TRADE MARK.

The word

TARRAMIA.

## NAME.

ERNEST WINNER LLOYD, of Bobinawarrarah, in the State of Victoria, Commonwealth of Australia, Farmer.

No. of class: 6.  
Description of goods: Machines for weighing or measuring skimmed milk.

No. of application: 5124.  
Date: 18th January, 1905.

## TRADE MARK.

The word

TUSSICURA.

## NAME.

SAMUEL JOHN EVANS, Chemist, trading as the "Tussicura Manufacturing Company," of Dunedin, Otago, New Zealand.

No. of class: 3.  
Description of goods: A medicine for human consumption.

No. of application : 5125.  
Date : 18th January, 1905.

TRADE MARK.

The words

**MOUNTAIN KING.**

NAME.

SAMUEL JOHN EVANS, Chemist, trading as the "Tussicura Manufacturing Company," of Dunedin, Otago, New Zealand.

No. of class : 3.

Description of goods : A preparation for human use.

F. WALDEGRAVE,  
Registrar.

*Trade Marks registered.*

**L**IST of Trade Marks registered from the 12th January to the 25th January, 1905, inclusive:—

- No. 3906; 4957.—A. Christie; Class 42. (*Gazette* No. 91, of the 10th November, 1904.)
- No. 3907; 4992.—W. J. Kingsland; Class 50. (*Gazette* No. 91, of the 10th November, 1904.)
- No. 3908; 4499.—H. Price and Co., Limited; Class 42. (*Gazette* No. 6, of the 21st January, 1904.)
- No. 3909; 4502.—H. Price and Co., Limited; Class 42. (*Gazette* No. 6, of the 21st January, 1904.)
- No. 3910; 4512.—Carr and Son; Class 50. (*Gazette* No. 91, of the 10th November, 1904.)
- No. 3911; 4935.—W. and A. McArthur, South Africa, Limited; Class 42. (*Gazette* No. 91, of the 10th November, 1904.)
- No. 3912; 4960.—E. C. Hadfield; Class 42. (*Gazette* No. 91, of the 10th November, 1904.)
- No. 3913; 4978.—The Electro-Silicon Company; Class 50. (*Gazette* No. 91, of the 10th November, 1904.)
- No. 3914; 4981.—R. Graham; Class 42. (*Gazette* No. 91, of the 10th November, 1904.)
- No. 3915; 4983.—H. J. Manson; Class 7. (*Gazette* No. 91, of the 10th November, 1904.)
- No. 3916; 4984.—R. Middlemas; Class 45. (*Gazette* No. 91, of the 10th November, 1904.)
- No. 3917; 4985.—The Hon. C. A. Parsons; Class 6. (*Gazette* No. 91, of the 10th November, 1904.)

- No. 3918; 4989.—Felton, Grimwade, and Co.; Class 42. (*Gazette* No. 91, of the 10th November, 1904.)
- No. 3919; 4761.—The Union Oil, Soap, and Candle Company, Limited; Class 47. (*Gazette* No. 59, of the 7th July, 1904.)
- No. 3920; 4777.—The Union Oil, Soap, and Candle Company, Limited; Class 47. (*Gazette* No. 59, of the 7th July, 1904.)
- No. 3921; 4988.—Southern Medical and Manufacturing Company; Class 3. (*Gazette* No. 91, of the 10th November, 1904.)
- No. 3922; 4897.—Keith, Ramsay, and Co.; Class 47. (*Gazette* No. 77, of the 15th September, 1904.)
- No. 3923; 4996.—Chrystall and Co.; Class 50. (*Gazette* No. 91, of the 10th November, 1904.)
- No. 3924; 4991.—Holbrooks, Limited; Class 42. (*Gazette* No. 91, of the 10th November, 1904.)

F. WALDEGRAVE,  
Registrar.

*Trade Mark Renewal Fees paid.*

**F**EEES paid for the renewal of the undermentioned Trade Marks for fourteen years from the date first mentioned:—

- No. 187/391.—14th March, 1905.—Colgate and Co., of New York, U.S.A. 18th January, 1905.
- Nos. 190/169 and 191/170. 20th March, 1905. J. Oakey and Sons, of London, England. 13th January, 1905.

F. WALDEGRAVE,  
Registrar.

*Subsequent Proprietors of Trade Marks registered.*

[NOTE.—The name of the former proprietor is given in brackets. The date is that of registration.]

- Nos. 773/612 and 2662/2098.—Norman Harper Bell, of Dunedin, New Zealand, Tea-merchant. [R. Wilson and Co.] 16th January, 1905.
- No. 72/47.—H. de Cabanas y Carbajal, a corporation organized and existing under and by virtue of the laws of the State of New Jersey, United States of America, with a business office at 111, Fifth Avenue, New York City, State of New York, United States of America. [L. Carvajal y Ca.] 25th January, 1905.
- No. 1374/1097.—Henry Clay, and Bock and Co., Limited, of London, England, and Havana, in the Island of Cuba, Cigar-manufacturers. A company registered in London aforesaid. [Juan Cueto y Hno.] 16th January, 1905.

F. WALDEGRAVE,  
Registrar.

*Alphabetical List of Applicants for Letters Patent for Quarter ending 31st December, 1904.*

THIS list includes also (1) applications lodged prior to but gazetted during the quarter, (2) complete specifications following provisional specifications accepted and gazetted during the quarter. Where the number and date of the *Gazette* are omitted, the application has not yet been accepted.

\* Denotes a provisional specification.

† Denotes a prior date under section 106 of "The Patents, Designs, and Trade Marks Act, 1889."

Name, Address, and Invention.	Application.		Gazette.	
	No.	Date.	No.	Date.
Abell, E. G., and another, Brisbane, Q. Butter-box. (S. J. Collins) ..	18516	24 Sept. ..	102	22 Dec.
Adams, J., and another, Hamilton, Vic. Pipe-wrench ..	18530	27 Sept. ..	91	10 Nov.
Adamson, L., Waimate, N.Z. Rain-water collector ..	18754	16 Nov. ..	102	22 Dec.
Alcock and Co., Wellington, N.Z. (See H. U. Alcock, No. 18525.)				
Alcock, F. A., Melbourne, Vic. (See H. U. Alcock, No. 18525.)				
Alcock, H. U., Melbourne, Vic. Convertible billiard-table ..	18517	24 Sept. ..	91	10 Nov.
Alcock, H. U., Wellington, N.Z. Preparing surface of bowl-testing table. (F. A. Alcock)	18525	1 Oct. ..	102	22 Dec.
Aldis, M., Auckland, N.Z. Billy-can ..	18669	28 Oct. ..	91	10 Nov.*
Alexander, C. J., London, Eng. Incandescent gas-burner ..	18853	13 Dec. ..	6	26 Jan., 1905.
Alexander, W. M., Bairnsdale, Vic. (See J. H. Smith, No. 18469.)				
Allan, A. T. W., and another, Thames, N.Z. Gold-saving ..	18777	18 Nov. ..	98	8 Dec.*
Allen, A. H. R., and another, Melbourne, Vic. Metal-finishing process and product	18748	16 Nov. ..	95	24 Nov.*
Allen, C. E. H., Hunterville, N.Z. Fencing-dropper ..	18700	3 Nov. ..	..	..
Anderson, G., Christchurch, N.Z. (See Christchurch Meat Company, Limited, No. 18456)				
Anderson, J., Dunedin, N.Z. Pressure-appliance for cheese-press ..	18651	20 Oct. ..	95	24 Nov.
Andrews, F. H., Sydenham, N.Z. Pithing-spear ..	18591	14 Oct. ..	86	27 Oct.*
Angus, A. R., Neutral Bay, N.S.W. Railway car ..	18714	8 Nov. ..	..	..
Angus, E. A., Melbourne, Vic. Sewing-machine ..	18693	3 Nov. ..	98	8 Dec.
Appleton, J. A., and another, Sydney, N.S.W. Anti-fouling composition	18637	18 Oct. ..	95	24 Nov.
Armstrong, G., Dunedin, N.Z. Elevating and delivering material ..	18775	21 Nov. ..	102	22 Dec.
Ashcroft, T., Auckland, N.Z. Increasing speed of vessels ..	18701	1 Nov. ..	95	24 Nov.*
Ashworth, H., Wellington, N.Z. Wool-washer ..	18573	10 Oct. ..	91	10 Nov.
Ashworth, H., Wellington, N.Z. Arrival and departure indicator for railways	18762	18 Nov. ..	98	8 Dec.*
Atkinson, H. A., Christchurch, N.Z. Blind-fitting ..	18772	19 Nov. ..	3	12 Jan., 1905.*
Austin, G. B. H., Oakleigh, Vic. Adjusting wind-gauge on rifle ..	18546	4 Oct. ..	86	27 Oct.*
Austin, G. B. H., Oakleigh, Vic. Vernier for rifle ..	18453	15 Sept. ..	86	27 Oct.*
Austin, G. B. H., Oakleigh, Vic. Ladder and frame for rifle ..	18620	20 Oct. ..	91	10 Nov.*
Austin, G. B. H., Oakleigh, Vic. Fixing spirit-level on rifle-sight ..	18521	29 Sept. ..	91	10 Nov.*
Bacon, M., Grey Lynn, N.Z. Blouse and skirt supporter ..	18776	17 Nov. ..	3	12 Jan., 1905.*
Baggstrom, E. L., Auckland, N.Z. (See G. W. Basley, No. 18891.)				
Bailey, C. E., Dunedin. Spring equaliser for vehicle ..	18541	4 Oct. ..	86	27 Oct.*
Baker, A. G., Dunedin, N.Z. Door-lock ..	17965	26 May ..	102	22 Dec.
Baker, H. J., Christchurch, N.Z. Churn ..	18554	6 Oct. ..	86	27 Oct.*
Baldwin, E. S., and another, Wellington, N.Z. Bread-making. (Deutsche Dauerbrot Gesellschaft)	18806	19 Dec., 1903†	..	..
Baldwin, E. S., and another, Wellington, N.Z. Parcel-carrier. (Lamson Store Service Company, Limited)	18875	20 Dec. ..	..	..
Barclay, W. R., and another, Leicester, Eng. (See United Shoe Machinery Company, No. 18752.)				
Barlow, J. L., and another, Wellington, N.Z. Die for cake-tins ..	17595	1 March ..	102	22 Dec.
Barnes, G., North Sydney, N.S.W. Curtain-suspender ..	18820	1 Dec. ..	3	12 Jan., 1905.*
Barton, B. C., Birmingham, Eng. Metallic bedstead ..	17465	13 Jan. ..	86	27 Oct.
Basley, G. W., Auckland, N.Z. Stair-rod. (L. Baggstrom) ..	18891	22 Dec. ..	3	12 Jan. 1905.*
Bates, A., and another, Leicester, Eng. (See United Shoe Machinery Company, No. 18752.)				
Baugh, De. (See under De.)				
Bavay, de. (See under De.)				
Beamish, W., Cromwell, N.Z. (See A. J. Park, No. 18896.)				
Beck, H., Meiningen, Ger. Electric arc lamp ..	18512	28 Sept. ..	91	10 Nov.
Bedell, H. H., and another, London, Eng. Current-collector for stud contact systems of electric traction	18723	10 Nov. ..	98	8 Dec.
Belk, M., Palmerston North, N.Z. Branding and embossing carcasses of mutton	18672	27 Oct. ..	..	..
Bender, L., Launceston, Tas. Butter-cutter ..	18467	21 Sept. ..	86	27 Oct.
Bernays, C. E., Brisbane, Q. Bogies for vehicles ..	18464	20 Sept. ..	86	27 Oct.
Bickerton, A. W., Christchurch, N.Z. Paper health shelter ..	17522	5 Feb. ..	98	8 Dec.
Billens, A., Christchurch, N.Z. Agitating attachment to spray-pump ..	18659	25 Oct. ..	95	24 Nov.
Blackstone, E. C., and another, Stamford, Eng. Swath-turner ..	18804	29 Nov. ..	102	22 Dec.
Böhm, H., Berlin, Ger. Preserve-can ..	18624	20 Oct. ..	..	..
Bower, D., Dunedin, N.Z. Milk-can ..	18770	18 Nov. ..	98	8 Dec.*
Boyle, J. S., and another, Auckland, N.Z. Boot-sole ..	18649	19 Oct. ..	91	10 Nov.
Boyle, J. S., and others, Auckland, N.Z. Boot sole and upper	18779	19 Nov. ..	98	8 Dec.*
Brackett, F. W., Colchester, Eng. (See Positive Rotary Pumps (Limited) No. 18599.)				
Bradley, S. A., and another, Kilmore, Vic. Fruit-case ..	18715	10 Nov. ..	98	8 Dec.*
Brake, C., Lincoln, N.Z. Surgical instrument for cattle ..	18656	24 Oct. ..	95	24 Nov.
Brake, J., Christchurch, N.Z. Attaching breeching-straps to vehicle-shafts	17629	7 March ..	95	24 Nov.
Brett, A. G., and another, Hawera, N.Z. Moustache-guard for spoons ..	17559	23 Feb. ..	102	22 Dec.
Brewerton, F. M., Motupiko, N.Z. Wire-strainer ..	18788	25 Nov. ..	..	..
Brice, H., Kapuni, N.Z. Game ..	17460	13 Jan. ..	91	10 Nov.

ALPHABETICAL LIST OF APPLICANTS FOR LETTERS PATENT—continued.

Name, Address, and Invention.	Application.		Gazette.	
	No.	Date.	No.	Date.
Bridge, A., Stonehenge, Q. Cricket-stumps .. .. .	18485	22 Sept.	86	27 Oct.
Bridger, J., London, Eng. (See the New Inverted Incandescent Gas-lamp Company, Limited, No. 18326.)				
Broadhead, C., and another, Wellington, N.Z. Knife and fork cleaner ..	18824	3 Dec.	98	8 Dec.*
Brown, F. J., Ngairu, N.Z. Leg-roping appliance .. .. .	18868	16 Dec.	102	22 Dec.*
Brown, F. J., Ngairu, N.Z. Cow-bailing appliance .. .. .	18867	16 Dec.	102	22 Dec.*
Brown, J. H., and another, Wellington, N.Z. Vending-machine ..	18548	5 Oct.	86	27 Oct.*
Brown, J. H., Leicester, Eng. (See United Shoe Machinery Company, No. 18625.)				
Brown, T. H., Wellington, N.Z. Bridle .. .. .	17410	24 Dec., 1903	86	27 Oct.
Bruce, J. L., Kogarah, N.S.W. Gas-lamp lighter and extinguisher ..	18722	10 Nov.	98	8 Dec.
Bruce, W. W., Wellington, N.Z. Fireproof roofs and floors. (J. R. Little)	18740	8 Nov.	102	22 Dec.
Buckelew, A., San Francisco, U.S.A. (See G. G. Turri, No. 18852.)				
Burchett, E., Christchurch, N.Z. Tire-cover, metallic .. .. .	18781	22 Nov.	98	8 Dec.*
Burt, A., Dunedin, N.Z. Self-closing tap .. .. .	18643	19 Oct.	91	10 Nov.*
Buscke, G. R., and others, Gisborne, N.Z. Racing-hurdle .. .. .	18575	7 Oct.	95	24 Nov.*
Butterworth, H. R., Dunedin, N.Z. Dredge-bucket. (H. Park) ..	18895	22 Dec.	3	12 Jan. 1905.*
Byron, A. H., Auckland, N.Z. Smoke-consumer and feeder for furnace	18747	12 Nov.	95	24 Nov.*
Cairns, P., Timaru, N.Z. Centre for invert and arching work ..	18650	22 Oct.	91	10 Nov.*
Cameron, E. A., and another, Invercargill, N.Z. Race for sheep ..	18899	23 Dec.	3	12 Jan. 1905.*
Campbell, P., Albert Park, Vic. Pipe-moulding machine .. .. .	18529	27 Sept.	91	10 Nov.
Campbell, W. S., Auckland, N.Z. Blight-destroyer .. .. .	18765	14 Nov.	98	8 Dec.*
Candy, H. W., Christchurch, N.Z. Tug-stop for vehicle-shafts ..	18744	15 Nov.	95	24 Nov.*
Cannon, T., Wanganui, N.Z. Anti-rattler for windows .. .. .	18841	7 Dec.	102	22 Dec.*
Carlaw, J., and another, Auckland, N.Z. Fire-bridge and smoke-consumer	18865	14 Dec.	102	22 Dec.*
Cassel, H. R., London, Eng. Slimes-filter .. .. .	17600	2 March	102	22 Dec.
Champion Seal Company, New York, U.S.A. Packing-case. (H. A. Penrose)	18813	1 Dec.	3	12 Jan., 1905.
Champion Seal Company, New York, U.S.A. Seal or stopper. (E. D. Schmitt)	18816	1 Dec.	..	..
Chewings, G., Mossburn, N.Z. Fencing-staple .. .. .	17501	29 Jan.	91	10 Nov.
Christchurch Meat Company, Limited, Christchurch, N.Z. Securing top of preserving-tin. (G. Anderson)	18456	16 Sept.	91	10 Nov.*
Christie, J., Dunedin, N.Z. Making union joints in pipes .. .. .	18532	30 Sept.	86	27 Oct.*
Christy, S. B., Berkeley, U.S.A. (See F. A. Rich, No. 18638.)				
Clapham, G. H., and another, Wellington. Die for cake-tins .. ..	17595	1 March	102	22 Dec.
Clark, A. Z., Melbourne, Vic. Treating crushed ores .. .. .	18818	1 Dec.	3	12 Jan., 1905.
Clark, D., Bairnsdale, Vic. Gold-separation, &c., by precipitation in zinc	18538	4 Oct.	86	27 Oct.*
Clark, H. S., Onehunga, N.Z. Tap for tins .. .. .	18874	16 Dec.	..	..
Clark, L., Hobsonville, N.Z. Flanging, &c., earthenware pipes ..	17105	13 Oct., 1903..	86	27 Oct.
Clark, R., Wanstead, Eng. Blank-book manufacture .. .. .	18805	4 Jan.†	3	..
Clark, R. O., jun., Hobsonville, N.Z. Flanging, &c., earthenware ..	17182	30 Oct., 1903..	86	27 Oct.
Clark, R. O., jun., Hobsonville, N.Z. Earthenware flanging-machine ..	18898	23 Dec.	3	12 Jan., 1905.*
Clere, F. de J., Wellington, N.Z. Reversible window-sash .. .. .	18674	29 Oct.	91	10 Nov.*
Clere, F. de J., Wellington, N.Z. Weatherboard .. .. .	18682	1 Nov.	91	10 Nov.*
Cloke, W. G., Patea, N.Z. Furnace for ironsand .. .. .	18734	11 Nov.	95	24 Nov.*
Cobb, J. H., and another, Christchurch, N.Z. Hair-pin .. .. .	18862	15 Dec.	102	22 Dec.*
Cohn, H., and another, London, Eng. Briquette-manufacture ..	18905	29 Dec.	3	12 Jan., 1905.*
Cohn, H., and another, London, Eng. (See J. T. Hunter, No. 18707.)				
Collins, H. A., Wellington, N.Z. Coat-hanger .. .. .	18539	4 Oct.	91	10 Nov.
Collins, J., Melbourne, Vic. Envelope, memorandum, or statement form	18627	20 Oct.	91	10 Nov.*
Collins, S. J., Brisbane, Q. (See J. Hancock and E. G. Abell, No. 18516.)				
Colton, A. R., Newark, U.S.A. (See N. L. R. Tracy, No. 18811.)				
Conolly, W. P., Melbourne, Vic. Safety appliance for shafts of elevators	18511	29 Sept.	91	10 Nov.
Cooper, F., Christchurch, N.Z. Disc ridger .. .. .	18660	25 Oct.	91	10 Nov.*
Cooper, F., Christchurch, N.Z. Tip road-wagon .. .. .	18732	10 Nov.	95	24 Nov.*
Corbett, F. J., South Yarra, Vic. (See H. Corbett, No. 18662.)				
Corbett, H., South Yarra, Vic. Siphon. (F. J. Corbett) .. .. .	18662	27 Oct.	91	10 Nov.*
Cosslett, R., Auckland, N.Z. Building-appliance .. .. .	18778	19 Nov.	102	22 Dec.*
Coulthard, T. W., Mangapai, N.Z. Binder for wire fences .. .. .	18655	25 Oct.	..	..
Cowie, J., and another, Dunedin, N.Z. Ball-testing appliance for bias ..	18609	15 Oct.	91	10 Nov.*
Craw, G., Linton, N.Z. Washing flax and similar fibre .. .. .	18561	7 Oct.	86	27 Oct.*
Cross, C. A., and another, Hamilton, Vic. Pipe-wrench .. .. .	18530	27 Sept.	91	10 Nov.
Crown Corporation, Limited, The, Sydney, N.S.W. Bottling carbonated liquid. (S. G. Plucknett and J. F. H. Howarth)	18579	13 Oct.	3	12 Jan., 1905.
Dahl, A., Riverstone, N.S.W. Rotary tine harrow .. .. .	18843	5 Dec.	..	..
Daily, J. J., Christchurch, N.Z. Pneumatic tire .. .. .	18336	16 Aug.	95	24 Nov.
Dale, A., Timaru, N.Z. Fencing-standard attachment .. .. .	18810	26 Nov.	98	8 Dec.*
Daly, W. P., Greymouth, N.Z. Adjusting bolsters .. .. .	17442	7 Dec., 1903	83	13 Oct.
Danks, T., Christchurch, N.Z. Windmill .. .. .	18825	1 Dec.	3	12 Jan., 1905.
Danks, T., Christchurch, N.Z. Oiling-appliance for machinery ..	18826	1 Dec.	3	12 Jan., 1905.
Darley, H. S., and another, Melbourne, Vic. Metal-finishing process and product. Trading as the Nella Enamelling and Japanning Company	18748	16 Nov.	95	24 Nov.*
Darvall, G. W., Wellington, N.Z. Bottle-stopper, measure, and eye-bath	18602	17 Oct.	91	10 Nov.*
Davis, P., Northcote, Vic. Clothes-strainer and transferrer to copper ..	18621	20 Oct.	95	24 Nov.
Dawes, J. T., Prestatyn, Eng. Magnetic separator .. .. .	18769	17 Nov.	102	22 Dec.
Dawson, A., and another, Mittagong, N.S.W. Cream-testing flask ..	18819	1 Dec.	3	12 Jan., 1905.
Dawson, J. G., Woodbury, N.Z. Egg-carrier .. .. .	18382	27 Aug.	95	24 Nov.
Dawson, W., Auckland, N.Z. Internal-combustion engine and vapouriser	18695	31 Oct.	98	8 Dec.

## ALPHABETICAL LIST OF APPLICANTS FOR LETTERS PATENT—continued.

Name, Address, and Invention.	Application.		Gazette.	
	No.	Date.	No.	Date.
De Baugh, H. W., Auckland, N.Z. Liner for washing-boiler .. ..	18890	21 Dec. ..	..	..
De Bavay, A. J. F., Kew, Vic. Ores, &c., separation by flotation ..	18688	3 Nov. ..	91	10 Nov.*
De Lantour, H. A., Dunedin, N.Z. Bowl-testing machine .. ..	18741	10 Nov. ..	95	24 Nov. *
Dellwik, C., London, Eng. (See J. T. Hunter, No. 18729.)				
Denmead, C. E., and another, Christchurch, N.Z. Jointing trap of water-closet, &c., to lead-away pipe	18636	19 Oct. ..	6	26 Jan., 1905.
Dennis, G., jun., Waikaia, N.Z. Raking material from sluice-box ..	17519	6 Feb. ..	98	8 Dec.
Dennison, J. G., Timaru, N.Z. Potato-digger .. ..	18774	21 Nov. ..	98	8 Dec.*
Denniston, S. E., Avenal, N.Z. Flax-treatment .. ..	17287	25 Nov., 1903	86	27 Oct.
Deutsche Dauerbrot Gesellschaft, Berlin, Ger. (See E. S. Baldwin and H. H. Rayward, No. 18806.)				
Dicke, H., Frankfort-on-Main, Ger. Generating gas .. ..	18728	10 Nov. ..	95	24 Nov.*
Dickie, R. J., and another, Wellington, N.Z. Vending-machine ..	18548	5 Oct. ..	86	27 Oct.*
Dignan, J., Auckland, N.Z. Castrating, ear-marking, and docking instrument	18767	17 Nov. ..	98	8 Dec.*
Dixie Match Company, New Jersey, U.S.A. Match-making art. (W. H. Parker)	18730	10 Nov. ..	98	8 Dec.
Donkin, H., Wellington, N.Z. Weed-eradicator .. ..	18794	28 Nov. ..	..	..
Droutledge, H., Auckland, N.Z. Registering and number-recording machine	18594	11 Oct. ..	91	10 Nov.
Ducker, J., jun., Warea, N.Z. Releaseable snatch-block .. ..	18542	4 Oct. ..	86	27 Oct.*
Dufaux, A., and another, Geneva, Switzerland. (See M. Ruty, No. 18802.)				
Dufaux, H., and another, Geneva, Switzerland. (See M. Ruty, No. 18802.)				
Dugins, W. F., Kew, Vic. Tobacco-pipe .. ..	18628	20 Oct. ..	95	24 Nov.
Dugins, W. F., Kew, Vic. Match-box and tobacco-cutter .. ..	18629	20 Oct. ..	95	24 Nov.
Dunbar, J., Invercargill, N.Z. Rake .. ..	18645	17 Oct. ..	91	10 Nov.*
Duncan, Limited, P. and D., Christchurch, N.Z. Turnip-puller. (G. Vucetich)	18571	8 Oct. ..	86	27 Oct.*
Dyke, A., Waipiata, N.Z. Lifting-jack .. ..	18717	7 Nov. ..	95	24 Nov.*
Dyke, A., Waipiata, N.Z. Trace-holder for swingletree .. ..	18718	7 Nov. ..	95	24 Nov.*
Dyke, A., Waipiata, N.Z. Rein-holder for vehicle .. ..	18719	7 Nov. ..	95	24 Nov.*
Easton, J. A., Dunedin, N.Z. Feed-box for horses .. ..	17398	18 Dec. 1903 ..	91	10 Nov.
Eckersley, J., Wellington, N.Z. Apparatus for spraying insecticides..	18549	5 Oct. ..	86	27 Oct.*
Edwards, A., and others, Melbourne, Vic. Harness-saddle .. ..	18894	29 Dec. ..	3	12 Jan. 1905.*
Edwards, G. B., and others, Melbourne, Vic. Harness-saddle ..	18894	29 Dec. ..	3	12 Jan. 1905.*
Edwards, T. Ballarat, Vic. Ore-roasting furnace .. ..	18878	21 Dec. ..	..	..
Edwards, W., and another, Waikino, N.Z. Window .. ..	18578	11 Oct. ..	3	12 Jan. 1905.
Ellen, J., Staveley, N.Z. Feeding-bottle protector .. ..	18900	29 Dec. ..	3	12 Jan. 1905.*
Elliott, E., and another, Auckland, N.Z. Cleaning and sorting tow ..	18545	14 Nov. ..	102	22 Dec.
Elliott, G. B. B., Melbourne, Vic. Street scavenger .. ..	18880	21 Dec. ..	..	..
Ellis, G. A., and another, Lithgow, N.S.W. Billiard-table .. ..	18663	27 Oct. ..	..	..
Elwarth, W. A., and others, Gisborne, N.Z. Racing-hurdle .. ..	18575	7 Oct. ..	95	24 Nov.*
Emery, S. J., Colac, Vic. Collar and hames .. ..	18622	20 Oct. ..	91	10 Nov.*
Evens, E. L., Malvern, S.A. Game .. ..	18817	1 Dec. ..	3	12 Jan. 1905.
Ever Fresh Bread Company, The, Berlin, Ger. (See E. S. Baldwin and H. H. Rayward, No. 18806.)				
Falkner, A., Wellington, N.Z. Drying milk .. ..	18551	5 Oct. ..	86	27 Oct.*
Falkner, A., Kaiparoro, N.Z. Forming moulding-boards for raised-panel work	18555	6 Oct. ..	91	10 Nov.
Ferguson, G. W., and another, Wangaratta, Vic. Brick-making machine	18671	25 Oct. ..	98	8 Dec.
Ferguson, G. W., and another, Wangaratta, Vic. Brick-making machine	18800	25 Nov. ..	98	8 Dec.*
Ferguson, J. W., and another, Wangaratta, Vic. Brick-making machine	18671	25 Oct. ..	98	8 Dec.
Ferguson, J. W., and another, Wangaratta, Vic. Brick-making machine	18800	25 Nov. ..	98	8 Dec.*
Finn, G., and another, Wellington, N.Z. Egg-carrier .. ..	18680	1 Nov. ..	91	10 Nov.*
Finn, G., and another, Wellington, N.Z. Egg-carrier .. ..	18795	28 Nov. ..	102	22 Dec.
Firth, T., Wellington, N.Z. Wheel-lock and horse-stopper .. ..	17446	9 Jan. ..	95	24 Nov.
Fisher, J., jun., Melbourne, Vic. Faucet.. ..	18580	13 Oct. ..	86	27 Oct.*
Fleming, J. A., London, Eng. (See Marconi's Wireless Telegraph Company, Limited, Nos. 18724 and 18725.)				
Fletcher, E. G., Southend-on-Sea, Eng. Cash-register .. ..	18611	19 Oct. ..	95	24 Nov.
Flynn, J., and another, Wellington, N.Z. Boot and shoe fastener ..	18822	2 Dec. ..	3	12 Jan., 1905.
Flynn, J., and another, Wellington, N.Z. Pocket .. ..	18831	3 Dec. ..	3	12 Jan., 1905.
Flynn, T. A., and another, Wellington, N.Z. Boot and shoe fastener ..	18822	2 Dec. ..	3	12 Jan., 1905.
Flynn, T. A., and another, Wellington, N.Z. Pocket .. ..	18831	3 Dec. ..	3	12 Jan., 1905.
Ford, S., and another, Dannevirke, N.Z. Compound for sleepers and building-blocks	18526	1 Oct. ..	86	27 Oct.*
Ford, S., and another, Dannevirke, N.Z. Manufacturing articles from boiled tar and mineral matter	18614	19 Oct. ..	91	10 Nov.*
Fowler, J. W., Auckland, N.Z. Electric belt .. ..	18888	23 Dec. ..	..	..
Fraser, J. C., Coromandel, N.Z. Steam-turbine .. ..	18864	12 Dec. ..	102	22 Dec.*
Freeman, J. S., and another, Dannevirke, N.Z. Compound for sleepers and building-blocks	18526	1 Oct. ..	86	27 Oct.*
Freeman, J. S., and another, Dannevirke, N.Z. Manufacturing of articles from boiled tar and mineral matter	18614	19 Oct. ..	91	10 Nov.*
Fry, G. H., Ashburton, N.Z. Bicycle-lock .. ..	18684	1 Nov. ..	95	24 Nov.
Fuller, J. H., Auckland, N.Z. Writing-desk, blackboard, and lithographic copy	18792	23 Nov. ..	98	8 Dec.*

ALPHABETICAL LIST OF APPLICANTS FOR LETTERS PATENT—continued.

Name, Address, and Invention.	Application.		Gazette.	
	No.	Date.	No.	Date.
Gallagher, J., Auckland, N.Z. Temperature fire-alarm .. ..	17996	4 June ..	102	22 Dec.
Gare, T., New Brighton, Eng. Wood, &c., treating .. ..	18859	14 Dec. ..	3	12 Jan., 1905.
Gasmier, F. W., Petersburg, S.A. Railway-brake mechanism ..	18501	28 Sept. ..	86	27 Oct.
Gaynor, J. A., Melbourne, Vic. Cork-retainer for bottles ..	18709	4 Nov. ..	95	24 Nov.*
Gemeinhardt, O., Footscray, Vic. Machine for measuring and wringing skins	18505	28 Sept. ..	86	27 Oct.
Gemmell, J., Maheno, N.Z. Stacking hay, &c. .. ..	17607	27 Feb. ..	102	22 Dec.
Gibb, W., and another, Oamaru, N.Z. Vehicle-seat slides .. ..	18735	8 Nov. ..	95	24 Nov.*
Gibbins, C. E., Auckland, N.Z. Model for teaching music .. ..	18845	5 Dec. ..	102	22 Dec.*
Gibbs, B., Stoke, N.Z. Spreader for traces .. ..	18657	26 Oct. ..	98	8 Dec.
Gibson, A. F., Timaru, N.Z. Flax-fibre treatment .. ..	18787	22 Nov. ..	102	22 Dec.*
Gilbert, T. J., and another, Brunswick, Vic. Dressing surfaces of rails ..	18537	30 Sept. ..	91	10 Nov.
Gill, A. E., Nelson, N.Z. Clamp for wire rope .. ..	18893	24 Dec. ..	6	26 Jan., 1905.
Gillies, A., Terang, Vic. Pneumatic teat-cups .. ..	17639	9 March ..	83	13 Oct.
Gillies, A. W., Georgetown, N.Z. Milk-can .. ..	18834	5 Dec. ..	102	22 Dec.*
Gilshnan, H. H., Kakarama, N.Z. Hay-knife .. ..	18595	15 Oct. ..	91	10 Nov.*
Glas, A., Berlin, Ger. Milk-powder .. ..	18720	10 Nov. ..	..	..
Glass, F. J., and another, Upper Fern-tree Gully, Vic. Diggers' boot-shields	18582	13 Oct. ..	86	27 Oct.*
Globe Proprietary Company, Limited, Auckland, N.Z. Hammock-support. (E. H. Littlejohn—W. H. Morehouse)	18647	22 Oct. ..	95	24 Nov.
Gordon, W., Boston, U.S.A. (See United Shoe Machinery Company, No. 17453.)				
Goudie, B., and another, Wellington, N.Z. Ash-pan .. ..	18812	1 Dec. ..	98	8 Dec.*
Grant, J., Napier, N.Z. Horse-shoe .. ..	18562	7 Oct. ..	..	..
Grant, J. B., Wallacetown, N.Z. Castrating-instrument .. ..	18615	19 Oct. ..	..	..
Grant, J. H., and another, Ballarat, Vic. Furnace for refractory ores ..	18838	6 Dec. ..	102	22 Dec.*
Grant, W. S., Temuka, N.Z. Adjustable shaft-stop .. ..	18566	6 Oct. ..	86	27 Oct.*
Gray, C. E., and another, Hobart, Tas. Coin-freed franking-machine ..	17386	17 Dec., 1903..	86	27 Oct.
Griffiths, W., and another, London, Eng. Current-collector for stud-contact system	18723	10 Nov. ..	98	8 Dec.
Grimsley, J. G., Leicester, Eng. Fire-extinguisher .. ..	18632	20 Oct. ..	95	24 Nov.
Grundy, E., Gisborne, N.Z. Portable woven-wire stretcher .. ..	18577	11 Oct. ..	95	24 Nov.*
Gunn, H., Auckland, N.Z. Smoke-consumer .. ..	18850	6 Dec. ..	3	12 Jan., 1905.*
Hadaway, J. B., Brockton, U.S.A. (See United Shoe Machinery Company, No. 18691.)				
Haenke, M. W., Ipswich, Q. Gas lighter and extinguisher .. ..	18661	27 Oct. ..	95	24 Nov.
Hall, E. J., Minneapolis, U.S.A. Sewing-machine needle .. ..	18808	1 Dec. ..	3	12 Jan., 1905.
Hall, G., and another, Lepperton, N.Z. Fencing-post .. ..	18331	15 Aug. ..	86	27 Oct.
Hamilton, F. W., and another, Nelson, N.Z. Ambulance-lifter .. ..	16927	21 Oct. ..	86	27 Oct.
Hamilton, W. E., Zanesville, U.S.A. Mining-machine .. ..	18504	28 Sept. ..	86	27 Oct.
Hancock, J., and another, Brisbane, Q. Butter-box. (S. J. Collins)	18516	24 Sept. ..	102	22 Dec.
Harding, H., Hauti, N.Z. Axe-handle .. ..	18892	24 Dec. ..	3	12 Jan., 1905.*
Harding, J., Maiden Bradley, Eng. Cheese-making apparatus	18612	19 Oct. ..	95	24 Nov.
Hare, A., Auckland, N.Z. Operating-valves .. ..	18886	23 Dec. ..	3	12 Jan., 1905.*
Hare, A., Auckland, N.Z. Telemeter .. ..	18887	23 Dec. ..	3	12 Jan., 1905.*
Harkness, B. G. A., Stratford, N.Z. Double-acting water-pump ..	18572	10 Oct. ..	86	27 Oct.*
Harris, T., and another, Petone, N.Z. Knife and fork cleaner .. ..	18824	3 Dec. ..	98	8 Dec.*
Hartnett, J., and another, Balwyn, Vic. Milking-machine .. ..	18303	11 Aug. ..	102	22 Dec.
Hawkeswood, C. S., Auckland, N.Z. Roofing tile and ridging .. ..	17541	11 Feb. ..	98	8 Dec.
Hayward, J., Melbourne, Vic. Liquid-delivering device for flushing-cistern	18583	13 Oct. ..	91	10 Nov.
Heath, T., Nelson, N.Z. Castrating-instrument .. ..	17378	16 Dec., 1903..	83	13 Oct.
Hedley, J., Neerim South, Vic. Cream-can covering .. ..	18746	15 Nov. ..	98	8 Dec.
Hement, T. C., Christchurch, N.Z. Forming O.G. spouting .. ..	18528	1 Oct. ..	83	13 Oct.*
Hement, T. C., Christchurch, N.Z. Forming sheet-iron ridging .. ..	18557	4 Oct. ..	86	27 Oct.*
Hement, T. C., Christchurch, N.Z. Ridging .. ..	18793	26 Nov. ..	98	8 Dec.*
Hemming, T., and another, Auckland, N.Z. Curtain hooks and fastenings	18574	6 Oct. ..	86	27 Oct.*
Henderson, G., jun., Purau, N.Z. Weed-eradicating solution .. ..	18835	5 Dec. ..	..	..
Henderson, G., Turakina, N.Z. Weed-destroying composition .. ..	18872	22 Dec. ..	..	..
Henderson, H. C., Wanganui, N.Z. Steam-turbine .. ..	18592	14 Oct. ..	91	10 Nov.*
Hendy, A. M., Dunedin, N.Z. Hair-pin .. ..	18897	22 Dec. ..	..	..
Henley, P., Palmerston North, N.Z. Hose-coupling .. ..	18726	10 Nov. ..	95	24 Nov.*
Herrick, J., Auckland, N.Z. Floor-washer .. ..	18716	10 Nov. ..	98	8 Dec.*
Hewton, A. L., Dunedin, N.Z. Sash raiser and lock. (J. O. Hewton) ..	18547	1 Oct. ..	95	24 Nov.
Hewton, J. O., Dunedin, N.Z. (See A. L. Hewton, No. 18547.)				
Hicks, T. J. A., and another, Auckland, N.Z. Wire-woven mattress ..	18454	15 Sept. ..	86	27 Oct.*
Hille, E. G. A., Kakanui, N.Z. Weed-eradicator .. ..	18807	29 Nov. ..	98	8 Dec.*
Hiscox, E. C., and another, London, Eng. (See P. M. Newton, No. 18755.)				
Holms, J., jun., Waimahaka, N.Z. Trace-spreader .. ..	18452	12 Sept. ..	102	22 Dec.
Homes, L., and another, Blenheim, N.Z. Fire-escape .. ..	18560	5 Oct. ..	86	27 Oct.*
Honore, C. J., Otakeho, N.Z. Milk-cooler .. ..	18753	16 Nov. ..	98	8 Dec.
Horman, C. E., Ashburton, N.Z. Rotary scraping-board .. ..	18757	16 Nov. ..	..	..
Hornidge, F. E., South Yarra, Vic. Culinary utensil and lid .. ..	18712	8 Nov. ..	98	8 Dec.
Horniman, A. L., and another, Mittagong, N.S.W. Cream-testing flask	18819	1 Dec. ..	3	12 Jan., 1905.
Hoskins, W., La Grange, U.S.A. Treating fatty wood for paper-pulp production	18500	28 Sept. ..	86	27 Oct.
Howarth, J. F. H., and another, Annandale, N.S.W. (See The Crown Corporation, Limited, No. 18579.)				
Hoyland, W., Wellington, N.Z. Couch .. ..	17512	4 Feb. ..	98	8 Dec.
Hunt, J., Waimate, N.Z. Hay-knife .. ..	18727	10 Nov. ..	..	..

ALPHABETICAL LIST OF APPLICANTS FOR LETTERS PATENT—*continued.*

Name, Address, and Invention.	Application.		Gazette.	
	No.	Date.	No.	Date.
Hunter, J. T., Wellington, N.Z. Ironsand briquettes. (T. Rouse and H. Cohn)	18707	7 Nov. ..	6	26 Jan., 1905.
Hunter, J. T., Wellington, N.Z. Water-gas production. (C. Oellwik)..	18729	10 Nov. ..	95	24 Nov.*
Hussey, J. M., Brunswick, Vic. Packing butter .. ..	18858	14 Dec. ..	3	12 Jan., 1905.
Ingram, G., and another, Lower Moutere, N.Z. Wire-strainer ..	18544	4 Oct. ..	..	..
Jackson, J. D., Prahara, Vic. Bath-heater .. ..	18686	3 Nov. ..	91	10 Nov.*
Jackson, J. D., Prahara, Vic. Gas-burner for bath-heater .. ..	18687	3 Nov. ..	91	10 Nov.*
Jackson, J. D., Prahara, Vic. Beer-engine .. ..	18902	29 Dec. ..	3	12 Jan., 1905.*
Jacobsen, J. S. M., Nelson, N.Z. Production of metals from ores ..	18909	31 Dec. ..	..	..
James, C., and others, Grantham, Eng. Internal-combustion engine..	18633	20 Oct. ..	95	24 Nov
Jardine, W. R., and another, Edinburgh, Scot. (See T. C. Jenkins and W. T. Mack, No. 18839.)				
Jenkins and Mack. (See T. C. Jenkins and W. T. Mack, No. 18839.)				
Jenkins, T. C., and another, Wellington, N.Z. Milking-machine. (W. Stewart and W. R. Jardine)	18839	6 Dec. ..	3	12 Jan., 1905.
Jerome, C., Perth, W.A. Incandescent oil-lamp .. ..	18696	3 Nov. ..	95	24 Nov.*
Johanson, A., Dillmanstown, N.Z. Gold-saving apparatus .. ..	18832	3 Dec. ..	102	22 Dec.*
Johns, W. F., Auckland, N.Z. Operating doors of lift or elevator wells	18613	19 Oct. ..	91	10 Nov.*
Johnson, C. J., and another, Auckland, N.Z. Fire-bridge and smoke-consumer	18865	14 Dec. ..	102	22 Dec.*
Johnson, W. C., and another, Old Charlton, Kent, Eng. Rock-drill ..	18610	19 Oct. ..	91	10 Nov.*
Johnston, W. J., Rooksprings, U.S.A. Panoramic camera .. ..	18783	24 Nov. ..	102	22 Dec.
Johnstone, A. E., London, Eng. Liquid-fuel burner .. ..	18721	10 Nov. ..	98	8 Dec.
Jones, H. T., and another, Melbourne, Vic. Blower for furnace ..	18883	22 Dec. ..	..	..
Jones, M. J., and another, New Plymouth, N.Z. Valve .. ..	18593	11 Oct. ..	95	24 Nov.
Jones, W. B., Hastings, N.Z. Spring tine cultivator .. ..	18705	7 Nov. ..	95	24 Nov.*
Karl, V., Rotorua, N.Z. Weed-eradicator .. ..	18866	16 Dec. ..	102	22 Dec.*
Kelly, R. D., Pigeon Bay, N.Z. Breeching for harness .. ..	18773	21 Nov. ..	98	8 Dec.*
Kennedy, S. R., Philadelphia, U.S.A. (See E. Phillips, No. 18598.)				
King, J., Masterton, N.Z. Turnip- and rape-seed sower .. ..	18784	24 Nov. ..	3	12 Jan., 1905.*
Kingsland, W., London, Eng. Electric switch .. ..	18856	14 Dec. ..	3	12 Jan., 1905.
Kitchin, H., and another, Hawthorn, Vic. Strap-lock .. ..	18569	7 Oct. ..	86	27 Oct.*
Knutzen, H. P., and others, Auckland, N.Z. Racing-hurdle .. ..	18575	7 Oct. ..	95	24 Nov.*
Koch, G., New York, U.S.A. Shaving-brush .. ..	18478	22 Sept. ..	86	27 Oct.
Krause, A. H., Auckland, N.Z. Box .. ..	18881	19 Dec. ..	6	26 Jan., 1905.*
Krause, A. H., Auckland, N.Z. Deck-chair .. ..	18882	19 Dec. ..	6	26 Jan., 1905.*
Kwiatkowski, L. F., New York, U.S.A. Brick and artificial-stone making	18815	1 Dec. ..	3	12 Jan., 1905.
Lamp Manufacturing Company, Limited, London, Eng. Railway signal-lamp. (W. H. I. Welch)	18861	13 Dec. ..	6	26 Jan., 1905.
Lamson Store Service Company, Limited, London, Eng. (See E. S. Baldwin and H. H. Rayward, No. 18875.)				
Larsen, T., and another, Waikino, N.Z. Window .. ..	18578	11 Oct. ..	3	12 Jan., 1905.
Lashlie, C., Temuka, N.Z. Coat and trouser hanger .. ..	18756	16 Nov. ..	95	24 Nov.*
Lautour, de. (See under De.)				
Law, R., Melbourne, Vic. Temperature-regulator for incubator ..	18692	3 Nov. ..	98	8 Dec.
Lawrence, A. L., and another, Christchurch, N.Z. Packing eggs ..	17273	19 Nov. 1903..	83	13 Oct.
Lawrence, F. J., and another, Christchurch, N.Z. Packing eggs ..	17273	19 Nov. 1903..	83	13 Oct.
Legg, J. C., Auckland, N.Z. Attaching handles of bakers' peels ..	18668	28 Oct. ..	91	10 Nov.*
Legg, J. C., Auckland, N.Z. Attaching handles of bakers' peels ..	18829	3 Dec. ..	..	..
Legg, J. C., Auckland, N.Z. Bread .. ..	18870	17 Dec. ..	..	..
Liebold, R., Weimar, Ger. Cement-manufacture .. ..	18849	24 Feb.† ..	..	..
Little, J. R., Edinburgh, Scot. (See W. W. Bruce, No. 18740.)				
Littlejohn, E. H., Auckland, N.Z. (See Globe Proprietary Company, Limited, No. 18647.)				
Livingston, T. L., and another, London, Eng. (See P. M. Newton, No. 18755.)				
Ljungström, F., Stockholm, Sweden. Cow-milker .. ..	17489	20 Jan. ..	91	10 Nov.
Lock, J., and another, Auckland, N.Z. Curtain hooks and fastenings..	18574	6 Oct. ..	..	..
London, W. T., Kimbolton, N.Z. Plant-pot .. ..	18830	3 Dec. ..	3	12 Jan., 1905.
Low, A., Reefton, N.Z. Links of endless chains .. ..	18681	1 Nov. ..	..	..
Lowe, A., Hastings, N.Z. Thinning and weeding knife .. ..	18910	31 Dec. ..	6	26 Jan., 1905.
Lowe, G. I., Palmerston North, N.Z. Flax-scatcher .. ..	17371	15 Dec., 1903..	83	13 Oct.
Lowry, G. A., Chicago, U.S.A. Cotton-picking machine .. ..	18743	15 Nov. ..	98	8 Dec.
Lubbers, J. H., Allegheny, U.S.A. (See Window-glass Machine Company, No. 18837.)				
Ludeman, J. P., and another, Melbourne, Vic. Blower for furnace ..	18883	22 Dec. ..	..	..
Ludford, W. H., Wellington, N.Z. Illuminating trolley-wheel of electric car	18540	4 Oct. ..	86	27 Oct.*
Luke, E. T., Melbourne, Vic. (See W. J. Rae, No. 18749.)				
Lungley, C. F., Melbourne, Vic. Manufacture of iron and steel from New Zealand ironsand	16975	5 Aug. 1903†	83	13 Oct.
Lyons, T. P., Wellington, N.Z. Vehicle-wheel tire .. ..	17579	26 Feb. ..	102	22 Dec.
Macdonald, D. C., Campbelltown, N.Z. Drying and bleaching flax ..	18641	21 Oct. ..	91	10 Nov.*
Mack, W. T., and another, Wellington, N.Z. Milking-machine. (W. Stewart and W. R. Jardine)	18839	6 Dec. ..	3	12 Jan., 1905.
Mackay, J. (Tertius), and another, Nelson, N.Z. Ambulance-lifter ..	16927	21 Oct. ..	86	27 Oct.
Madder, W., New Plymouth, N.Z. Non-refillable stopper .. ..	18823	3 Dec. ..	3	12 Jan., 1905.*



ALPHABETICAL LIST OF APPLICANTS FOR LETTERS PATENT—*continued.*

Name, Address, and Invention.	Application.		Gazette.	
	No.	Date.	No.	Date.
Maddox, F. W., Auckland, N.Z. Broom .. .. .	18713	8 Nov. ..	95	24 Nov.*
Magnus, P., Northcote, Vic. Pneumatic tires .. .. .	18631	20 Oct. ..	95	24 Nov.
Mahlstedt, G. Melbourne, Vic. Candle-protector .. .. .	18848	8 Dec. ..	..	..
Mahoney, F. J., and another, Christchurch, N.Z. Jointing trap of water-closet to lead-away pipe	18636	19 Oct. ..	6	26 Jan., 1905.
Malcolm, A. J., Blenheim, N.Z. Fencing-staple .. .. .	18789	23 Nov. ..	3	12 Jan., 1905.*
Marconi's Wireless Telegraph Company, Limited, London, Eng. Telegraphic signalling-keys. (J. A. Fleming)	18724	10 Nov. ..	98	8 Dec.
Marconi's Wireless Telegraph Company, Limited, London, Eng. Transmitting-instrument. (J. A. Fleming)	18725	10 Nov. ..	98	8 Dec.
Markey, F., and another, St. Mary's, Perth, Canada. Churn and butter-worker	18857	14 Dec. ..	..	..
Marr, A., Invercargill, N.Z. Curtain-poles .. .. .	18758	14 Nov. ..	..	..
Marsh, R. F., East Maitland, N.S.W. Washing-machine .. .. .	17988	1 June ..	86	27 Oct.
Matheson, A., Melbourne, Vic. Postal wrapper .. .. .	18699	3 Nov. ..	95	24 Nov.
Matheson, D., Martinborough, N.Z. Overcoat .. .. .	18667	28 Oct. ..	91	10 Nov.*
May, T. W., Auckland, N.Z. Steam-exhaust for rotary turbine ..	18766	14 Nov. ..	98	8 Dec.*
Mayo, B. F., Salem, U.S.A. (See United Shoe Machinery Company, No. 18751.)	..	..	..	..
McCallum, D., Invercargill, N.Z. Mixture for curing fish, bacon, &c. ..	18733	11 Nov. ..	95	24 Nov.*
McColl, A., Onehunga, N.Z. Rectifying defects and repairing timber-veneer	18652	21 Oct. ..	91	10 Nov.*
McCubbin, J. B., North Fitzroy, Vic. Boot-heel .. .. .	18903	29 Dec. ..	6	26 Jan., 1905.
McDonald, A., and another, Riccarton, N.Z. Rod for wheel .. .. .	17099	10 Oct., 1903..	91	10 Nov.
McDonald, A., and another, Dunedin, N.Z. Milk-strainer .. .. .	18871	16 Dec. ..	102	22 Dec.*
McDonald, H. E., Wellington, N.Z. Egg-preserving process.. .. .	18702	4 Nov. ..	95	24 Nov.*
McDonald, J. C., and another, Christchurch, N.Z. Separating wild oats from other grain	18833	3 Dec. ..	102	22 Dec.*
McDonald, S., and another, Gore, N.Z. Screw-key for nuts and bolts..	18801	29 Nov. ..	..	..
McFeely, R. F., Beverly, U.S.A. (See United Shoe Machinery Company No. 18626.)	..	..	..	..
McGregor, R., Selwyn, N.Z. Twitch-cutter and harrow .. .. .	18588	10 Oct. ..	86	27 Oct.*
McGuire, P. J., and another, Goulburn, N.S.W. Billiard-table .. .. .	18663	27 Oct. ..	..	..
McKay, A., Sydney, N.S.W. Excavating and elevating wash-dirt ..	18750	16 Nov. ..	95	24 Nov.*
McKay, R., Wendonside, N.Z. Truck .. .. .	18759	14 Nov. ..	95	24 Nov.*
McKay, W. A. and another, Wellington, N.Z. Hair-pin .. .. .	18862	15 Dec. ..	102	22 Dec.*
McKeegan, W., Wellington, N.Z. Branding-device .. .. .	18863	15 Dec. ..	102	22 Dec.*
McLauchlan, E. M., Invercargill, N.Z. Photographing images for abnormal pictures	18550	5 Oct. ..	86	27 Oct.*
McLean, A., Titree Point, N.Z. Tire-protector .. .. .	18564	8 Oct. ..	86	27 Oct.*
McLennan, R. M., Dunedin, N.Z. Calendar .. .. .	18906	29 Dec. ..	6	26 Jan., 1905.
McLeod, H. N., Wellington, N.Z. Gold-saving table .. .. .	18782	22 Nov. ..	98	8 Dec.*
McLeod, J. W., Waikaka, N.Z. Gold-saving apparatus .. .. .	18590	14 Oct. ..	91	10 Nov.*
McMurray, S., and another, Christchurch, N.Z. Suspending pictures ..	17480	20 Jan. ..	95	24 Nov.
McPhee, J. H. A., Dunedin, N.Z. Reducing pulverised iron-ore .. .. .	18490	20 Sept. ..	86	27 Oct.
Mercer, T., Stratford, N.Z. Sole or sock for boots, &c. .. .. .	18635	20 Oct. ..	91	10 Nov.*
Minchin, J., Gloucester, Eng. Bins for dry goods .. .. .	18796	23 Nov. ..	102	22 Dec.
Mitthell, H., Invercargill, N.Z. Lead-pencil .. .. .	18646	18 Oct. ..	91	10 Nov.*
Monrad, D. G., and another, Palmerston North, N.Z. Milk-stirrer ..	18768	19 Nov. ..	98	8 Dec.*
Moore, D., Timaru, N.Z. Turnip and rape sower .. .. .	18556	3 Oct. ..	86	27 Oct.*
Moore, R. J., Rangitikei, N.Z. Milk-aerator .. .. .	17514	4 Feb. ..	98	8 Dec.
Morehouse, W. H., Wasco, U.S.A. (See Globe Proprietary Company, Limited, No. 18647.)	..	..	..	..
Moses, W., Willowby, N.Z. Californian-thistle exterminator .. .. .	18617	19 Oct. ..	91	10 Nov.*
Mouat, B. J., South Dunedin, N.Z. Draught-regulator for grate .. ..	18515	24 Sept. ..	91	10 Nov.
Moyle, G. F., Dunedin, N.Z. Music-leaf turner .. .. .	18559	4 Oct. ..	86	27 Oct.*
Munro, H., Longbush, N.Z. Mud-guard for vehicle .. .. .	18596	15 Oct. ..	..	..
Murray, R. L. H., Auckland, N.Z. Reflecting-apparatus and advertising-medium	18600	13 Oct. ..	..	..
Murray, R. L. H., Auckland, N.Z. Acetylene-gas generator .. .. .	18710	2 Nov. ..	6	26 Jan., 1905.
Nathan, L., Zurich, Switzerland. Brewing beer .. .. .	18679	1 Nov. ..	98	8 Dec.
Naumkeag Buffing-machine Association. (See S. W. Winslow, No. 18689.)	..	..	..	..
Nella Enamelling and Japanning Company. (See A. H. R. Allen and H. S. Darby, No. 18748.)	..	..	..	..
New Inverted Incandescent Gas-lamp Company, Limited, The, London, Eng. Mantle-support. (J. Bridger)	18326	17 Aug. ..	98	8 Dec.
Newth, F. E., Wellington, N.Z. Match-lining cramp .. .. .	18606	18 Oct. ..	91	10 Nov.*
Newton, P. M., Christchurch, N.Z. Clothes washer and dryer. (E. C. Hiscox and T. L. Livingston)	18755	14 Nov. ..	98	8 Dec.
Nicholson, H. H., Pukeuri, N.Z. Bird-trap .. .. .	18821	1 Dec. ..	98	8 Dec.*
Nielsen, N., Wellington, N.Z. Building-block .. .. .	18666	28 Oct. ..	91	10 Nov.*
Nisbet, W., Dunedin, N.Z. Dredge-ladder attachment .. .. .	18873	19 Dec. ..	102	22 Dec.*
Nixon, W. C., and another, New Plymouth, N.Z. Valve .. .. .	18593	11 Oct. ..	95	24 Nov.
Norrie, W. M., Auckland, N.Z. Potato-peeler .. .. .	18869	16 Dec. ..	102	22 Dec.*
Norris, W., Smithfield, S.A. Wire-strainer .. .. .	18844	5 Dec. ..	3	12 Jan., 1905.
Norton, F. G., Lyttelton, N.Z. Egg-carrier .. .. .	18570	7 Oct. ..	86	27 Oct.*
O'Brien, T. E., Narrabri, N.S.W. Bottle .. .. .	17157	29 Oct., 1903..	86	27 Oct.
O'Connor, T. B., Auckland, N.Z. Bit and bridle .. .. .	18736	8 Nov. ..	98	8 Dec.
Ohlsson, J. A., New York, U.S.A. Liner for separator .. .. .	18884	22 Dec. ..	..	..
Orr, J., jun., Waitohi, N.Z. Sheaf-conveyer .. .. .	18771	19 Nov. ..	98	8 Dec.*

## ALPHABETICAL LIST OF APPLICANTS FOR LETTERS PATENT—continued.

Name, Address, and Invention.	Application.		Gazette.	
	No.	Date.	No.	Date.
Owen, R. H., Wellington, N.Z. Range-finder .. .. .	18670	28 Oct. ..	91	10 Nov.*
Paddock, H. J., West Wyalong, N.S.W. Wind-gauge sight for rifle ..	18664	27 Oct. ..	..	..
Palmer, E. M., Christchurch, N.Z. Pen or pencil holder .. .. .	18604	18 Oct. ..	..	..
Palmer, J. S., Wanganui, N.Z. Account-book .. .. .	18522	30 Sept. ..	86	27 Oct.*
Park, A. J., and another, Auckland, N.Z. Cleaning and sorting tow ..	18545	14 Nov. ..	102	22 Dec.
Park, A. J., Auckland, N.Z. Suspending and operating window-sash ..	17447	19 Jan. ..	98	8 Dec.
Park, A. J., Dunedin, N.Z. Gold-saving appliance. (W. Beamish) ..	18896	22 Dec. ..	3	12 Jan., 1905.*
Park, H., Sydney, N.S.W. (See H. R. Butterworth, No. 18895.)				
Parker, W. H., Jersey City, U.S.A. (See The Dixie Match Company, No. 18730.)				
Parkerson, C. P., Thames, N.Z. Receptacle for perishable condiments	18608	18 Oct. ..	91	10 Nov.*
Partridge, J. T., and another, Gisborne, N.Z. Weed-eradicating composition	18678	29 Oct. ..	91	10 Nov.*
Paten, F. T., Melbourne, Vic. Producing slags for making mineral wool	18587	13 Oct. ..	86	27 Oct.*
Paterson, J., and another, Thames, N.Z. Gold-saving .. .. .	18777	18 Nov. ..	98	8 Dec.*
Paterson, W. H., Gore, N.Z. Pneumatic tire .. .. .	18860	12 Dec. ..	102	22 Dec.*
Patten, A., and another, Hawthorn, Vic. Strap-lock .. .. .	18569	7 Oct. ..	86	27 Oct.*
Pearson, G. C., and another, Old Charlton, Kent, Eng. Rock-drill ..	18610	19 Oct. ..	91	10 Nov.*
Penrose, H. A., New York, U.S.A. (See Champion Seal Company, No. 18813.)				
Peterson, C., Dublin, Ireland. Tobacco-pipe, &c., mouthpiece .. ..	17838	27 April ..	91	10 Nov.
Phillips, E., Melbourne, Vic. Process of treating milk. (S. R. Kennedy)	18598	13 Oct. ..	91	10 Nov.
Phillips, E., Melbourne, Vic. Cream products and apparatus for making same. (C. M. Taylor)	18630	20 Oct. ..	6	26 Jan., 1905.
Pike, A. S., and another, Wellington, N.Z. Egg-carrier .. .. .	18680	1 Nov. ..	91	10 Nov.*
Pike, A. S., and another, Wellington, N.Z. Egg-carrier .. .. .	18795	28 Nov. ..	3	12 Jan., 1905.*
Pim, F. A., Hawthorn, Vic. Maize-drill .. .. .	18846	8 Dec. ..	102	22 Dec.*
Plucknett, S. G., and another, Newtown, N.S.W. (See The Crown Corporation, Limited, No. 18579.)				
Plucknett, S. G., and another, Newtown, N.S.W. Ore separator and classifier	18584	13 Oct. ..	91	10 Nov.
Plucknett, S. G., and another, Newtown, N.S.W. Vibrating-trough for concentrating metalliferous materials	18585	13 Oct. ..	91	10 Nov.
Plucknett, S. G., and another, Newtown, N.S.W. Extracting mineral particles from slimes and tailings	18586	13 Oct. ..	91	10 Nov.
Plummer, C., Auckland, N.Z. (See C. B. and G. W. Plummer, No. 18675.)				
Plummer, C. B., and another, Auckland, N.Z. (trading as C. Plummer). Hat	18675	29 Oct. ..	91	10 Nov.*
Plummer, G. W., and another, Auckland, N.Z. (trading as C. Plummer). Hat	18675	29 Oct. ..	91	10 Nov.*
Pollard, E. T., London, Eng. Fluid-pressure turbine .. .. .	18879	20 Dec. ..	3	12 Jan., 1905.*
Porter, E. E., Ashburton, N.Z. Turnip and rape feed .. .. .	18618	19 Oct. ..	91	10 Nov.*
Positive Rotary Pumps (Limited), London, Eng. Pump for liquids or fluids (F. W. Brackett)	18599	13 Oct. ..	91	10 Nov.
Potts, T. W., Wanganui, N.Z. Bicycle stand or support .. .. .	18607	18 Oct. ..	91	10 Nov.*
Prince, H., Westmere, N.Z. Leg-fastener for animals .. .. .	18543	4 Oct. ..	91	10 Nov.
Prior, A., Dunedin, N.Z. Box .. .. .	18278	2 Aug. ..	86	27 Oct.
Pritchard, W. M., and another, Auckland, N.Z. Boot-sole .. .. .	18649	19 Oct. ..	91	10 Nov.
Pritchard, W. M., and others, Auckland, N.Z. Boot sole and upper ..	18779	19 Nov. ..	98	8 Dec.*
Pugh, J., Sydney, N.S.W. Consumption cure .. .. .	18697	3 Nov. ..	95	24 Nov.*
Rae, W. J., Melbourne, Vic. Time-table and advertising-device. (E. T. Luke)	18749	16 Nov. ..	..	..
Ramsay, W. E. S., and another, St. Albans, N.Z. Suspending pictures	17480	20 Jan. ..	95	24 Nov.
Rask, C., and another, Invercargill, N.Z. Race for sheep .. .. .	18899	23 Dec. ..	3	12 Jan., 1905.*
Rasmussen, N., Mauriceville West, N.Z. Machine-belt fastener ..	18356	23 Aug. ..	91	10 Nov.
Raymond, F. V., Invercargill, N.Z. Plate-rack .. .. .	18854	10 Dec. ..	102	22 Dec.*
Rayward, H. H., and another, Wellington, N.Z. Bread-making. (Deutsche Dauerbrot Gesellschaft)	18806	19 Dec., 1903†	..	..
Rayward, H. H., and another, Wellington, N.Z. Parcel-carrier. (Lamson Store Service Company Limited)	18875	20 Dec. ..	..	..
Read, H., Alma, N.Z. Rail-bed plate .. .. .	18567	7 Oct. ..	86	27 Oct.
Read, J. C. C., London, Eng. Petroleum-burner .. .. .	18634	20 Oct. ..	91	10 Nov.*
Reichel, L. T., Wellington, N.Z. Wind and water motor .. .. .	18640	21 Oct. ..	91	10 Nov.*
Rich, F. A., Auckland, N.Z. Recovery of gold and silver from cyanide solutions. (S. B. Christy)	18638	18 Oct. ..	95	24 Nov.
Richard, M., and another, Glasgow, Scot. Bakers' oven .. .. .	18531	29 Sept. ..	91	10 Nov.
Richardson, F., and another, St. Mary's, Perth, Canada. Churn and butter-worker	18857	14 Dec. ..	..	..
Ridder, E. F., and another, Christchurch, N.Z. Traction-engine governor-gear	18901	29 Dec. ..	3	12 Jan., 1905.*
Ridder, E. H. C., and another, Christchurch, N.Z. Traction-engine governor-gear	18901	29 Dec. ..	3	12 Jan., 1905.*
Ridgway, J. J., Rosebank, U.S.A. Belt-conveyor .. .. .	18648	22 Oct. ..	95	24 Nov.
Roberts, D., and others, Grantham, Eng. Internal-combustion engine	18633	20 Oct. ..	95	24 Nov.
Robertson, C., Dunedin, N.Z. Laundry apparatus .. .. .	17440	7 Jan. ..	102	22 Dec.
Robertson, D., Wellington, N.Z. Envelope .. .. .	18558	3 Oct. ..	86	27 Oct.*
Robertson, D., Wellington, N.Z. Making self-addressed envelopes ..	18836	3 Dec. ..	102	22 Dec.*
Robertson, D., Wellington, N.Z. Envelope .. .. .	18708	4 Nov. ..	95	24 Nov.*

ALPHABETICAL LIST OF APPLICANTS FOR LETTERS PATENT—continued.

Name, Address, and Invention.	Application.		Gazette.	
	No.	Date.	No.	Date.
Robertson, E. L., Wellington, N.Z. Egg-carrier .. .. .	18907	30 Dec. ..	3	12 Jan. 1905.*
Robinson, W. S., and another, Invercargill, N.Z. Air-engine ..	18904	29 Dec. ..	3	12 Jan., 1905.*
Robison, D. M., and another, St. Kilda, Vic. Milking-machine ..	18303	11 Aug. ..	102	22 Dec.
Robson, S. W., and another, Wellington, N.Z. Ash-pan ..	18812	1 Dec. ..	98	8 Dec.*
Rodgers, J. T., Waimate, N.Z. Securing shafts to vehicles ..	18673	25 Oct. ..	91	10 Nov.*
Rogers, A. W., Beverley, U.S.A. (See S. W. Winslow, No. 18689.)				
Rooney, J. W., Caversham, N.Z. Trolley-pole for electric traction ..	18786	24 Nov. ..	98	8 Dec.*
Ross, A., and another, Napier, N.Z. Binder-twine .. .. .	18642	21 Oct. ..	95	24 Nov.
Ross, J. F., and another, Greytown, N.Z. Coiling and uncoiling fencing-wire	18876	20 Dec. ..	3	..
Ross, W., and another, Napier, N.Z. Binder-twine .. .. .	18642	21 Oct. ..	95	24 Nov.
Roudebush, F. L., London, Eng. Rock-drilling engine. (C. H. Shaw)	18827	1 Dec. ..	3	12 Jan., 1905.
Rouse, T., and another, London, Eng. Briquette-manufacture ..	18905	29 Dec. ..	3	12 Jan., 1905.*
Rouse, T., and another, London, Eng. (See J. T. Hunter, No. 18707.)				
Rowland, J. H., Waipukurau, N.Z. Game .. .. .	18492	24 Sept. ..	86	27 Oct.
Russell, J., Christchurch, N.Z. Rounding, chamfering, and trueing heads of casks	18603	17 Oct. ..	86	27 Oct.*
Russell, R. A. C., Walsall, Eng. Riding- and driving-saddle-tree ..	18388	26 March† ..	102	22 Dec.
Rutland, J., Canvastown, N.Z. Treating wooden piles .. .. .	18563	8 Oct. ..	..	..
Rutty, M., Sydney, N.S.W. Motor for cycle. (H. and A. Dufaux) ..	18802	29 Nov. ..	98	8 Dec.*
Ryan, M., Cobden, N.Z. Plush for gold-saving .. .. .	18576	11 Oct. ..	91	10 Nov.*
Scherer, A., Mangatoki, N.Z. Hand seed-drill and cultivator ..	18742	15 Nov. ..	95	24 Nov.*
Schmidt, W. S. D., Auckland, N.Z. Protecting soles of boots and shoes	18639	18 Oct. ..	91	10 Nov.*
Schmitt, E. D., Brooklyn, U.S.A. (See Champion Seal Company, No. 18816.)				
Schnitzer, H., Dresden, Ger. Food-warmer .. .. .	17422	30 Dec., 1903	83	13 Oct.
Scott, W., and another, Glasgow, Scot. Bakers' oven .. .. .	18531	29 Sept. ..	91	10 Nov.
Searle, W. E., and another, Oamaru, N.Z. Vehicle-seat slides ..	18735	8 Nov. ..	95	24 Nov.*
Sears, F. W., Wellington, N.Z. Lithographic plate .. .. .	17685	22 March ..	98	8 Dec.
Seifert, H., Invercargill, N.Z. Water scutching-attachment ..	17819	20 April ..	83	13 Oct.
Seifert, H., Invercargill, N.Z. Flax-milling machinery .. .. .	18619	13 Oct. ..	91	10 Nov.
Sellers, W. J., Christchurch, N.Z. Skewers, &c., manufacture	17379	16 Dec., 1903	95	24 Nov
Setchell, E. L., and another, Sydney, N.S.W. Electric belt ..	18694	31 Oct. ..	..	..
Shaw, C. H., Denver, U.S.A. (See F. L. Roudebush, No. 18827.)				
Shelton, F. J., Wellington, N.Z. Acetylene-generator .. .. .	18462	19 Sept. ..	86	27 Oct.
Shoemaker, H., Jersey City, U.S.A. Wireless telegraphy ..	18731	10 Nov. ..	102	22 Dec
Sibbit, J. M., Hawthorn, Vic. Roller for wire-gauze screen ..	18519	29 Sept. ..	91	10 Nov.*
Sim, W., Invercargill, N.Z. Oil-gas .. .. .	18760	8 Nov. ..	95	24 Nov.*
Simmonds, J., Pukerua, N.Z. Reel wire-strainer .. .. .	18790	23 Nov. ..	3	12 Jan., 1905.
Simmonds, R., Coromandel, N.Z. Egg-carrier .. .. .	18739	14 Nov. ..	95	24 Nov.*
Simpson, C. T., Balclutha, N.Z. Cow-bail .. .. .	18908	31 Dec. ..	3	12 Jan., 1905.*
Simpson, D., Auckland, N.Z. Cleaning and polishing knives, &c. ..	18711	3 Nov. ..	95	24 Nov.*
Simpson, W. S., London, Eng. Propelling bicycles .. .. .	18623	20 Oct. ..	95	24 Nov.
Sinclair, W., Stratford, N.Z. Draught-regulator .. .. .	18763	18 Nov. ..	98	8 Dec.*
Skinner, J. R., Christchurch, N.Z. Cushion heel for boot ..	17402	22 Dec., 1903	86	27 Oct.
Small, J., Port Chalmers, N.Z. Water-tube boiler .. .. .	18597	14 Oct. ..	91	10 Nov.*
Smart, A., jun., and another, Auckland, N.Z. Box for heating blankets, &c.	18653	21 Oct. ..	91	10 Nov.*
Smethurst, E., Christchurch, N.Z. Controlling speed of screw-propelled ships	17606	1 March ..	102	22 Dec.
Smith, C. B., Dunedin, N.Z. Numbering and recording machine ..	18920	29 Dec. ..	..	..
Smith, E. D., and another, Gisborne, N.Z. Weed-eradicating composition	18678	29 Oct. ..	91	10 Nov.*
Smith, E. R., Buffalo, U.S.A. Shaft-bearings .. .. .	18885	22 Dec. ..	6	26 Jan., 1905.
Smith, E. S., Timaru, N.Z. Securing stair-rods in position ..	18703	4 Nov. ..	..	..
Smith, H., and another, Blenheim, N.Z. Fire-escape .. .. .	18560	5 Oct. ..	86	27 Oct.*
Smith, J. D., Dunedin, N.Z. Process for dressing flax .. .. .	18565	5 Oct. ..	86	27 Oct.*
Smith, J. H., Bairnsdale, Vic. Gate-post "fall." (W. M. Alexander)	18469	22 Sept. ..	86	27 Oct.
Snowden, J., Northern Wairoa, N.Z. Bullock-bow key .. .. .	17534	8 Feb. ..	98	8 Dec.
Soulas, C., Wanganui, N.Z. Telescope .. .. .	17496	25 Jan. ..	95	24 Nov.
Spray, F., and another, Dunedin, N.Z. Hook-and-eye fastening ..	18568	7 Oct. ..	95	24 Nov.*
Sprey, E., and another, Dunedin, N.Z. Hook-and-eye fastening ..	18568	7 Oct. ..	95	24 Nov.*
Sprott, J., Chertsey, N.Z. Bird-trap .. .. .	18706	5 Nov. ..	95	24 Nov.*
Starrett, D. W., San Francisco, U.S.A. Compressed-air pump ..	18698	3 Nov. ..	6	26 Jan., 1905.
Stedman, S. R., and another, Dunedin, N.Z. Rod for wheel ..	17099	10 Oct., 1903	91	10 Nov.
Stedman, S. R., and another, Dunedin, N.Z. Milk-strainer ..	18871	16 Dec. ..	102	22 Dec.*
Stephens, P. A. S., Ashbuton, N.Z. Boot-cleaning machine ..	18761	14 Nov. ..	98	8 Dec.*
Stevenson, G., Woolston, N.Z. Mop-wringer for bucket .. ..	18889	23 Dec. ..	3	12 Jan., 1905.*
Stevenson, G. S., and another, Gore, N.Z. Key for screwing nuts and bolts	18801	29 Nov. ..	..	..
Stevenson, G. S., Gore, N.Z. Cork-seal .. .. .	18534	30 Sept. ..	86	27 Oct.*
Stevenson, G. S., Gore, N.Z. Furniture drawers .. .. .	18533	30 Sept. ..	86	27 Oct.*
Stewart, W., and another, Edinburgh, Scot. (See T. C. Jenkins and W. T. Mack, No. 18839.)				
Stowell, F., St. Andrews, N.Z. Sash-fastener .. .. .	18589	10 Oct. ..	91	10 Nov.*
Strain, A., Belfast, Ireland. Utilising the resistance of motion ..	18683	1 Nov. ..	95	24 Nov.*
Strain, J. J., Christchurch, N.Z. Gas-stove .. .. .	18828	3 Dec. ..	3	12 Jan., 1905.
Sutherland, D. G., Linwood, N.Z. Tobacco-cutter .. .. .	18851	12 Dec. ..	102	22 Dec.*
Sutherland, G. G., and another, Hawera, N.Z. Moustache-guard for spoons	17559	23 Feb. ..	102	22 Dec.
Suttie, C., and another, Onehunga, N.Z. Flax-treatment .. ..	18917	31 Dec. ..	6	26 Jan., 1905.*
Swanson, P. S., and another, Invercargill, N.Z. Air-engine .. ..	18904	29 Dec. ..	3	12 Jan. 1905.*

ALPHABETICAL LIST OF APPLICANTS FOR LETTERS PATENT—*continued.*

Name, Address, and Invention.	Application.		Gazette.	
	No.	Date.	No.	Date.
Swyny, E. J., and another, Balmain, N.S.W. Ore separator and classifier	18584	13 Oct. ..	91	10 Nov. <sup>2</sup>
Swyny, E. J., and another, Balmain, N.S.W. Vibrating-trough for concentrating metalliferous materials	18585	13 Oct. ..	91	10 Nov.
Swyny, E. J., and another, Balmain, N.S.W. Extracting mineral particles from slimes and tailings	18586	13 Oct. ..	91	10 Nov.
Symes, H., Harrietville, Vic. Elevating alluvial earths, &c. ..	18605	14 Oct. ..	91	10 Nov.
Tait, A. L. J., Richmond, Vic. Treating and dressing flax .. ..	18601	17 Oct. ..	86	27 Oct.*
Taylor, A., Dunedin, N.Z. Cistern .. .. ..	18676	26 Oct. ..	91	10 Nov.*
Taylor, C. M., Philadelphia, U.S.A. (See E. Phillips, No. 18630.)				
Templeton, W. J., Dunkeld, Vic. Roofing-nail .. .. ..	18814	1 Dec. ..	..	..
Terry, W. H., Addington, N.Z. Window-sash .. .. ..	18616	18 Oct. ..	91	10 Nov.*
Thomas, R., and another, Waitara, N.Z. Fencing-post .. ..	18331	15 Aug. ..	86	27 Oct.
Thomas, R. F., and another, Melbourne, Vic. Fruit-case .. ..	18715	10 Nov. ..	98	8 Dec.*
Thompson, C. E., and another, Lower Moutere, N.Z. Wire-strainer ..	18544	4 Oct. ..	..	..
Thomson, J., Invercargill, N.Z. Vehicle-wheel tire .. ..	18791	24 Nov. ..	98	8 Dec.*
Thwaites, E. J., Melbourne, Vic. Valve for automatic piano-player ..	18581	13 Oct. ..	86	27 Oct.*
Tinkham, A. H., Masterton, N.Z. Ear-punch .. .. ..	18685	2 Nov. ..	95	24 Nov.
Tolman, J. S., and another, Hobart, Tas. Coin-freed franking-machine	17386	17 Dec., 1903	86	27 Oct.
Toner, J. H., Waitahuna, N.Z. Vehicle-seat .. .. ..	18780	19 Nov. ..	98	8 Dec.*
Torrance, R. C., and another, Dunedin, N.Z. Ball-testing appliance for bias	18609	15 Oct. ..	91	10 Nov.*
Townsend, W. R. J., Wellington, N.Z. Applying electric light to pianos	18553	5 Oct. ..	86	27 Oct.*
Toxward, W. E., and another, Palmerston North, N.Z. Milk-stirrer ..	18768	19 Nov. ..	98	8 Dec.*
Tracy, N. L. R., Sydney, N.S.W. Invisible lacing for garments. (A. R. Colton)	18811	28 Nov. ..	98	8 Dec.*
Trembath, W., Gore, N.Z. Animal-cover .. .. ..	17667	16 March ..	102	22 Dec.
Turnbull, J. H. T., Auckland, N.Z. Fire-lighter .. .. ..	18738	8 Nov. ..	95	24 Nov.*
Turri, G. G. Melbourne, Vic. Safety-pin. (The Twin Safety-pin Company—A. Buckelew)	18852	13 Dec. ..	3	12 Jan., 1905.
Twin Safety-pin Company, The, San Francisco, U.S.A. (See G. G. Turri, No. 18852.)				
Twomey, J. M., Temuka, N.Z. Newspaper-folding machine .. ..	18552	5 Oct. ..	86	27 Oct.*
United Shoe Machinery Company, Paterson, U.S.A. Nailing-machine. (J. H. Brown)	18625	20 Oct. ..	95	24 Nov.
United Shoe Machinery Company, Paterson, U.S.A. Pounding-up machine. (R. F. McFeeley)	18626	20 Oct. ..	91	10 Nov.*
United Shoe Machinery Company, Paterson, U.S.A. Sole laying and levelling machine. (E. E. Winkley)	18690	3 Nov. ..	91	10 Nov.*
United Shoe Machinery Company, Paterson, U.S.A. Welt-operating machine. (J. B. Hadaway)	18691	3 Nov. ..	91	10 Nov.*
United Shoe Machinery Company, Paterson, U.S.A. Trimming and concaving heels. (B. F. Mayo)	18751	16 Nov. ..	95	24 Nov.*
United Shoe Machinery Company, Paterson, U.S.A. Nail-driving machine. (W. R. Barclay and A. Bates)	18752	16 Nov. ..	95	24 Nov.*
United Shoe Machinery Company, Paterson, U.S.A. Buffing-rolls. (W. Gordon.)	17453	12 Jan. ..	86	27 Oct.
Vaughan, D. G., Borung, Vic. (See O. T. Wills, No. 18840.)				
Vucetich, G., Chertsey, N.Z. (See P. and D. Duncan, Limited, No. 18571.)				
Waddle, C., and another, Dunedin, N.Z. Game .. .. ..	17478	15 Jan. ..	98	8 Dec.
Wagstaff, E. E., Melbourne, Vic. Lamp-burner .. .. ..	18797	25 Nov. ..	102	22 Dec.
Wagstaff, E. E., Melbourne, Vic. Lamp-burner .. .. ..	18798	25 Nov. ..	102	22 Dec.
Wagstaff, E. E., Melbourne, Vic. Thimble for lamp-burner .. ..	18799	25 Nov. ..	102	22 Dec.
Wales, R., Dunedin, N.Z. Coin-controlled machine .. .. ..	18251	28 July ..	102	22 Dec.
Walker, T., Levin, N.Z. Hoe .. .. ..	18842	7 Dec. ..	102	22 Dec.*
Walker, W. E., South Dunedin, N.Z. Ventilating-window .. ..	18644	19 Oct. ..	91	10 Nov.*
Walters, H., and another, Sydney, N.S.W. Anti-fouling and anti-corrosive composition	18637	18 Oct. ..	95	24 Nov.
Ward, H., Dunedin, N.Z. Scraping-attachment for brushes .. ..	18397	31 Aug. ..	91	10 Nov.
Ward, J. J., Wairau, N.Z. Tightening wire fences .. .. ..	18785	24 Nov. ..	98	8 Dec.*
Warry, J., and another, Birmingham, Eng. Incandescent gaslight ..	18737	18 July†	95	24 Nov.*
Waters, J. B., Dunedin, N.Z. Egg-tester .. .. ..	18658	24 Oct. ..	91	10 Nov.*
Watson, W. C., and another, Sydney, N.S.W. Electric belt .. ..	18694	31 Oct. ..	..	..
Watts, R. E., and another, Stamford, Eng. Swath-turner .. ..	18804	29 Nov. ..	102	22 Dec.
Way, R. F., and another, Auckland, N.Z. Woven-wire mattress ..	18454	15 Sept. ..	86	27 Oct.*
Welch, W. H. I., London, Eng. (See The Lamp Manufacturing Company, Limited, No. 18861.)				
Wetenhall, W., and others, Melbourne, Vic. Harness-saddle .. ..	18894	29 Dec. ..	3	12 Jan., 1905.*
Whisker, N. H., and another, Auckland, N.Z. Box for heating blankets, &c.	18653	21 Oct. ..	91	10 Nov.*
White, S., and another, Dunedin, N.Z. Game .. .. ..	17478	15 Jan. ..	98	8 Dec.
White, W., and others, Auckland, N.Z. Boot sole and upper .. ..	18779	19 Nov. ..	98	8 Dec.*
White, W. A., Hunua South, N.Z. Boat-paddle apparatus .. ..	18665	25 Oct. ..	..	..
Whitehouse, S. G., London, Eng. Wheeled vehicle .. .. ..	18429	2 Sept. ..	91	10 Nov.
Whitelaw, H. J., Palmerston North, N.Z. Clothes-peg .. .. ..	17581	27 Feb. ..	102	22 Dec.
Whitney, W. R., New York, U.S.A. Filament and method of manufacture	18503	28 Sept. ..	86	27 Oct.
Wiggins, W., and another, Greytown, N.Z. Coiling and uncoiling fencing-wire	18876	20 Dec. ..	..	..
Wigley, P., and another, Birmingham, Eng. Incandescent gaslight ..	18737	18 July†	95	24 Nov.*

ALPHABETICAL LIST OF APPLICANTS FOR LETTERS PATENT—*continued.*

Name, Address, and Invention.	Application.		Gazette.	
	No.	Date.	No.	Date.
Wilkinson, F., Petone, N.Z. Spouting-bracket .. ..	18704	5 Nov. ..	95	24 Nov.*
Williams, A. G. R., Cambridge, N.Z. Basting-apparatus .. ..	18855	14 Dec. ..	6	26 Jan., 1905.
Williams, D. J., Waimangaroa Junction. Flax cleaner and conveyer ..	18877	20 Dec. ..	6	26 Jan., 1905.*
Williams, W., Mount Gambier, S.A. Chaff-cutter .. ..	18745	15 Nov. ..	98	8 Dec.
Wills, O. T., Borung, Vic. Folding crate. (D. G. Vaughan) ..	18840	6 Dec. ..	102	22 Dec.*
Wilson, A. C., and another, Christchurch, N.Z. Separating wild oats from other grain	18833	3 Dec. ..	102	22 Dec.*
Wilson, J. F., Invercargill. Friction-clutch .. ..	18764	18 Nov. ..	98	8 <sup>1</sup> / <sub>2</sub> Dec.*
Wilson, N., and another, Auckland, N.Z. Chair-seat .. ..	17647	10 March ..	95	24 Nov.
Window-glass Machine Company, Pittsburg, U.S.A. Sheet-glass manufacture. (J. H. Lubbers)	18837	2 Dec. ..	3	12 Jan., 1905.
Winkley, E. E., Lynn, U.S.A. (See United Shoe Machinery Company, No. 18690.)				
Winslow, S. W., Beverley, U.S.A. Buffing-machine. (Naumkeag Buffing Machine Association—A. W. Rogers)	18689	3 Nov. ..	91	10 Nov.*
Wiseman, J., Auckland, N.Z. Sash-lock .. ..	17293	26 Nov., 1903	102	22 Dec.
Woltereck, H. C., London, Eng. Hydrocyanic acid, Process and production of	18803	29 Nov. ..	102	22 Dec.
Woltereck, H. C., London, Eng. Process of producing ammonia ..	18506	28 Sept. ..	86	27 Oct.
Woodford, C., Sydney, N.S.W. Disinfecting, &c., vessel for flushing cistern	18809	1 Dec. ..	98	8 Dec.*
Woodhead, A. E., and another, Upper Fern-tree Gully, Vic. Diggers' boot-shield	18582	13 Oct. ..	86	27 Oct.*
Woods, M., and another, Carlton, Vic. Dressing surface of rails ..	18537	30 Sept. ..	91	10 Nov.
Worsley, M. I., and another, Auckland, N.Z. Chair-seat .. ..	17647	10 March ..	95	24 Nov.
Wright, W. S., Christchurch, N.Z. Carburetter for kerosene ..	18847	6 Dec. ..	102	22 Dec.*
Wrigley, J. W., Rotorua, N.Z. Fixing sheets of corrugated-iron roofing	18654	25 Oct. ..	95	24 Nov.
Wynne, W. P., and another, Ballarat, Vic. Furnace for refractory ores	18838	6 Dec. ..	102	22 Dec.*
Wynyard, M. H., and another, Onehunga, N.Z. Flax-treatment ..	18917	31 Dec. ..	6	26 Jan., 1905.*
Yager, H., Fitzroy, Vic. Boot .. ..	18470	22 Sept. ..	86	27 Oct.
Young, J. W., and others, Grantham, Eng. Internal-combustion engine	18633	20 Oct. ..	95	24 Nov.
Ziele, C. W., Christchurch, N.Z. Shirt-cuff protector .. ..	18677	28 Oct. ..	95	24 Nov.*

Alphabetical List of Inventions for Quarter ending 31st December, 1904.

THIS list includes also (1) applications lodged prior to but gazetted during the quarter, (2) complete specifications following provisional specifications accepted and gazetted during the quarter. Where the number and date of the *Gazette* are omitted, the application has not yet been accepted.

\* Denotes a provisional specification. † Denotes a prior date under section 106 of "The Patents, Designs, and Trade Marks Act, 1889."

Invention.	Name.	Application.		Gazette.	
		No.	Date.	No.	Date.
Account-book .. ..	J. S. Palmer .. ..	18522	30 Sept. ..	86	27 Oct.*
Acetylene-generator .. ..	F. J. Shelton .. ..	18462	19 Sept. ..	86	27 Oct.
Acetylene-generator .. ..	R. L. H. Murray .. ..	18710	2 Nov. ..	6	26 Jan., 1905.
Advertising-device and time-table .. ..	W. J. Rae .. ..	18749	16 Nov. ..	..	..
Advertising-medium and reflecting-apparatus	R. L. H. Murray .. ..	18600	13 Oct. ..	..	..
Aerator, Milk- .. ..	R. J. Moore .. ..	17514	4 Feb. ..	98	8 Dec.
Agitator for spray-pump .. ..	A. Billens .. ..	18659	25 Oct. ..	95	24 Nov.
Air-engine .. ..	W. S. Robinson and P. S. Swanson	18904	29 Dec. ..	3	12 Jan., 1905.*
Air-pump, Compressed, Alarm. (See Fire-alarm.)	D. W. Starrett .. ..	18698	3 Nov. ..	6	26 Jan., 1905.
Ambulance-lifter .. ..	J. Mackay and F. W. Hamilton..	16927	21 Oct. ..	86	27 Oct.
Ammonia, Process of producing .. ..	H. C. Woltereck .. ..	18506	28 Sept. ..	86	27 Oct.
Amusement, Table- .. ..	C. H. Waddle and S. White ..	17478	15 Jan. ..	98	8 Dec.
Anti-fouling and anti-corrosive composition	H. Walters and J. A. Appleton..	18637	18 Oct. ..	95	24 Nov.
Anti-rattler for windows .. ..	T. Cannon .. ..	18841	7 Dec. ..	102	22 Dec.*
Arching work, Centres for .. ..	P. Cairns .. ..	18650	22 Oct. ..	91	10 Nov.*
Arc lamp, Electric .. ..	H. Beck .. ..	18512	28 Sept. ..	91	10 Nov.
Arrival and departure indicator, Train ..	H. Ashworth .. ..	18762	18 Nov. ..	98	8 Dec.*
Artificial-stone and brick manufacturing..	L. F. Kwiatkowski .. ..	18815	1 Dec. ..	..	12 Jan., 1905.
Artillery shooting, Range-finder for .. ..	R. H. Owen .. ..	18670	28 Oct. ..	91	10 Nov.*
Ashpan .. ..	S. W. Robson and B. Goudie ..	18812	1 Dec. ..	98	8 Dec.*
Axe-handle .. ..	H. Harding .. ..	18892	24 Dec. ..	3	12 Jan., 1905.*
Bacon-curing mixture .. ..	D. McCallum .. ..	18733	11 Nov. ..	95	24 Nov.*
Bail. (See Cow-bail.)					
Bakers' oven .. ..	M. Richard and W. Scott .. ..	18531	29 Sept. ..	91	10 Nov.
Bakers' peel, Attaching handle to .. ..	J. C. Legg .. ..	18668	28 Oct. ..	91	10 Nov.*
Bakers' peel, Attaching handle to .. ..	J. C. Legg .. ..	18829	3 Dec. ..	..	..
Ball-testing appliance .. ..	R. C. Torrance and J. Cowie ..	18609	15 Oct. ..	91	10 Nov.*

ALPHABETICAL LIST OF INVENTIONS—*continued.*

Invention.	Name.	Application.		Gazette.	
		No.	Date.	No.	Date.
Barrels, Machine for rounding, &c.	J. Russell .. .. .	18603	17 Oct. ..	86	27 Oct.*
Basting-apparatus .. .. .	A. G. R. Williams .. .. .	18855	14 Dec. ..	6	26 Jan., 1905.
Bath-heater .. .. .	J. D. Jackson .. .. .	18686	3 Nov. ..	91	10 Nov.*
Bath-heater, Gas-burner for .. .. .	J. D. Jackson .. .. .	18687	3 Nov. ..	91	10 Nov.*
Bath. (See Eye-bath.)					
Bearings. (See Shaft-bearings.)					
Bedstead, Metallic .. .. .	B. C. Barton .. .. .	17465	13 Jan. ..	86	27 Oct.
Beer-engine .. .. .	J. D. Jackson .. .. .	18902	29 Dec. ..	3	12 Jan., 1905.*
Beer-manufacture .. .. .	L. Nathan .. .. .	18679	1 Nov. ..	98	8 Dec.
Belt-conveyor .. .. .	J. J. Ridgway .. .. .	18648	22 Oct. ..	95	24 Nov.
Belt-fastener .. .. .	N. Rasmussen .. .. .	18356	23 Aug. ..	91	10 Nov.
Belt. (See also Electric belt.)					
Bias, Ball-testing, [appliance for .. .. .	R. C. Torrance and J. Cowie .. .. .	18609	15 Oct. ..	91	10 Nov.*
Bicycle-lock .. .. .	G. H. Fry .. .. .	18684	1 Nov. ..	95	24 Nov.
Bicycle, Propelling-apparatus for .. .. .	W. S. Simpson .. .. .	18623	20 Oct. ..	95	24 Nov.
Bicycle-stand .. .. .	T. W. Potts .. .. .	18607	18 Oct. ..	91	10 Nov.†
Bicycle. (See also Cycle.)					
Billiard-table .. .. .	H. U. Alcock .. .. .	18517	24 Sept. ..	91	10 Nov.
Billiard-table .. .. .	G. A. Elliss and P. J. McGuire .. .. .	18663	27 Oct. ..	..	..
Billy-can .. .. .	M. Aldis .. .. .	18669	28 Oct. ..	91	10 Nov.*
Bin for dry goods .. .. .	J. Minchin .. .. .	18796	23 Nov. ..	102	22 Dec.
Binder for wire fence .. .. .	T. W. Coulthard .. .. .	18655	25 Oct. ..	..	..
Binder-twine .. .. .	A. and W. Ross .. .. .	18642	21 Oct. ..	95	24 Nov.
Bird-trap .. .. .	H. H. Nicholson .. .. .	18821	1 Dec. ..	98	8 Dec.*
Bird-trap .. .. .	J. Sprott .. .. .	18706	5 Nov. ..	95	24 Nov.*
Bit and bridle for racehorse .. .. .	T. B. O'Connor .. .. .	18736	8 Nov. ..	98	8 Dec.
Blackboard .. .. .	J. H. Fuller .. .. .	18792	23 Nov. ..	98	8 Dec.*
Blank-book manufacture .. .. .	R. Clark .. .. .	18805	29 Nov. ..	..	..
Blight-eradicator .. .. .	W. S. Campbell .. .. .	18765	14 Nov. ..	98	8 Dec.*
Blind-fitting .. .. .	H. A. Atkinson .. .. .	18772	19 Nov. ..	3	12 Jan., 1905.*
Block. (See Building-block, Printing-block, Snatch-block.)					
Blouse and skirt support .. .. .	M. Bacon .. .. .	18776	17 Nov. ..	3	12 Jan., 1905.
Blower for furnace .. .. .	H. T. Jones and J. P. Ludeman .. .. .	18883	22 Dec. ..	..	..
Board. (See Moulding-board, Scraping-board, Weather-board.)					
Boat-paddle apparatus .. .. .	W. A. White .. .. .	18665	25 Oct. ..	..	..
Bogie .. .. .	C. E. Bernays .. .. .	18464	20 Sept. ..	86	27 Oct.
Boiler. (See Washing-boiler, Water-tube boiler.)					
Bolster-adjuster .. .. .	W. P. Daly .. .. .	17442	7 Dec., 1903	83	13 Oct.
Book. (See Account-book, Blank book.)					
Boot-fastener .. .. .	T. A. and J. Flynn .. .. .	18822	2 Dec. ..	3	12 Jan., 1905.
Boot-heel .. .. .	J. B. McCubbin .. .. .	18903	29 Dec. ..	6	26 Jan., 1905.
Boot or shoe .. .. .	H. Yager .. .. .	18470	22 Sept. ..	86	27 Oct.
Boot-polishing machine .. .. .	P. A. S. Stephens .. .. .	18761	14 Nov. ..	98	8 Dec.*
Boot-shield .. .. .	F. J. Glass and A. E. Woodhead.. .. .	18582	13 Oct. ..	86	27 Oct.*
Boot sole or sock .. .. .	T. Mercer .. .. .	18635	20 Oct. ..	91	10 Nov.*
Boot-sole .. .. .	W. M. Pritchard and J. S. Boyle.. .. .	18649	19 Oct. ..	91	10 Nov.
Boot sole and upper .. .. .	W. M. Pritchard, J. S. Boyle, and W. White .. .. .	18779	19 Nov. ..	98	8 Dec.*
Boot-sole protector .. .. .	W. S. D. Schmidt .. .. .	18639	18 Oct. ..	91	10 Nov.*
Boot or shoe heel .. .. .	J. R. Skinner .. .. .	17402	22 Dec., 1903	86	27 Oct.
Bottle .. .. .	T. E. O'Brien .. .. .	17157	29 Oct., 1903	86	27 Oct.
Bottle. (See also Feeding-bottle.)					
Bottle seal and stopper .. .. .	Champion Seal Company .. .. .	18816	1 Dec. ..	..	..
Bottle-stopper, measure, and eye-bath .. .. .	G. W. Darvall .. .. .	18602	17 Oct. ..	91	10 Nov.*
Bottling liquids .. .. .	The Crown Corporation, Limited .. .. .	18579	13 Oct. ..	3	12 Jan., 1905.
Bowl-tester .. .. .	H. A. de Lautour .. .. .	18741	10 Nov. ..	95	24 Nov.*
Bowl-testing table, Method of preparing surfaces of .. .. .	H. U. Alcock .. .. .	18525	1 Oct. ..	102	22 Dec.
Box. (See Butter-box, Feed-box, Match-box, Sluice-box.)					
Box .. .. .	A. H. Krause .. .. .	18881	19 Dec. ..	6	26 Jan., 1905,*
Box .. .. .	A. Prior .. .. .	18278	2 Aug. ..	86	27 Oct.
Box for heating blankets, &c. .. .. .	N. H. Whisker and A. Smart, jun. .. .. .	18653	21 Oct. ..	91	10 Nov.*
Bracket. (See Spouting-bracket.)					
Brake, Railway .. .. .	F. W. Gasmier .. .. .	18501	28 Sept. ..	86	27 Oct.
Branding-device .. .. .	W. McKeegan .. .. .	18863	15 Dec. ..	102	22 Dec.*
Branding-device .. .. .	M. Belk .. .. .	18672	27 Oct. ..	..	..
Breeching .. .. .	R. D. Kelly .. .. .	18773	21 Nov. ..	98	8 Dec.*
Breeching-strap, Attaching, to vehicle .. .. .	J. Brake .. .. .	17629	7 March ..	95	24 Nov.
Bread .. .. .	J. C. Legg .. .. .	18870	17 Dec. ..	..	..
Bread-making .. .. .	E. S. Baldwin and H. H. Rayward .. .. .	18806	29 Nov. ..	..	..
Brewing beer .. .. .	L. Nathan .. .. .	18679	1 Nov. ..	98	8 Dec.
Brick-making machine .. .. .	J. W. and G. W. Ferguson .. .. .	18671	25 Oct. ..	98	8 Dec.
Brick-making machine .. .. .	J. W. and G. W. Ferguson .. .. .	18800	25 Nov. ..	98	8 Dec.*
Brick-making .. .. .	L. F. Kwiatkowski .. .. .	18815	1 Dec. ..	3	12 Jan., 1905.
Bridle .. .. .	T. H. Brown .. .. .	17410	24 Dec., 1903	86	27 Oct.
Bridle and bit .. .. .	T. B. O'Connor .. .. .	18736	8 Nov. ..	98	8 Dec.
Briquettes. (See Ironsand briquettes.)					
Broom .. .. .	F. W. Maddox .. .. .	18713	8 Nov. ..	95	24 Nov.*
Brush. (See Shaving-brush.)					

ALPHABETICAL LIST OF INVENTIONS—continued.

Invention.	Name.	Application.		Gazette.	
		No.	Date.	No.	Date.
Brush, Scraping-attachment for ..	H. Ward .. ..	18397	31 Aug. ..	91	10 Nov.
Bucket, Dredge- .. ..	H. R. Butterworth .. ..	18895	29 Dec. ..	3	12 Jan., 1905.*
Bucket, Mop-wringer attachment to ..	G. Stevenson .. ..	18889	23 Dec. ..	3	12 Jan., 1905.*
Bucket, Mop-wringing attachment to ..	J. Herrick .. ..	18716	10 Nov. ..	98	8 Dec.*
Buffing-machine .. ..	S. W. Winslow .. ..	18689	3 Nov. ..	91	10 Nov.*
Buffing-roll .. ..	United Shoe Machinery Company	17453	12 Jan. ..	86	27 Oct.
Building-appliance .. ..	R. Cosslett .. ..	18778	19 Nov. ..	102	22 Dec.*
Building-block .. ..	N. Nielsen .. ..	18666	28 Oct. ..	91	10 Nov.*
Building-block, Compound for production of ..	S. Ford and J. S. Freeman ..	18526	1 Oct. ..	86	27 Oct.*
Bullock-bow key .. ..	J. Snowden .. ..	17534	8 Feb. ..	98	8 Dec.
Burner, (See Gas-burner, Incandescent gas-burner, Lamp-burner, Liquid-fuel burner, Petroleum-burner.)					
Butter-box .. ..	J. Hancock and E. G. Abell ..	18516	24 Sept. ..	102	22 Dec.
Butter-cutter .. ..	L. Bender .. ..	18467	21 Sept. ..	86	27 Oct.
Butter-packing apparatus .. ..	J. M. Hussey .. ..	18858	14 Dec. ..	3	12 Jan., 1905.
Butter-worker and churn .. ..	F. Richardson and F. Markey ..	18857	14 Dec. ..	..	..
Calendar .. ..	R. M. McLennan .. ..	18906	29 Dec. ..	6	26 Jan., 1905.
Camera .. ..	W. J. Johnston .. ..	18783	24 Nov. ..	102	22 Dec.
Can. (See Billy-can, Cream-can, Milk-can, Preserve-can.)					
Candle-protector .. ..	G. Mahlstedt .. ..	18848	8 Dec. ..	..	..
Carburetter for kerosene .. ..	W. S. Wright .. ..	18847	6 Dec. ..	102	22 Dec.*
Car. (See Electric car, Railway car.)					
Carrier. (See Egg-carrier, Fruit-carrier, Parcel-carrier.)					
Case. (See Fruit-case, Packing-case.)					
Cash-register .. ..	E. G. Fletcher .. ..	18611	19 Oct. ..	95	24 Nov.
Casks, Machine for rounding, &c. ..	J. Russell .. ..	18603	17 Oct. ..	86	27 Oct.*
Castrating-instrument .. ..	T. Heath .. ..	17378	16 Dec., 1903	83	13 Oct.
Castrating-instrument .. ..	J. Dignan .. ..	18767	17 Nov. ..	98	8 Dec.*
Castrating-instrument .. ..	J. B. Grant .. ..	18615	19 Oct. ..	..	..
Cement-manufacture .. ..	R. Liebold .. ..	18849	9 Dec. ..	..	..
Centre for invert work .. ..	P. Cairns .. ..	18650	22 Oct. ..	91	10 Nov.*
Chaff-cutter .. ..	W. Williams .. ..	18745	15 Nov. ..	98	8 Dec.
Chair-seat .. ..	N. Wilson, jun. and M. I. Worsley	17647	10 March ..	95	24 March.
Chair, Deck- .. ..	A. H. Krause .. ..	18882	19 Dec. ..	6	26 Jan., 1905.*
Cheese-making apparatus .. ..	J. Harding .. ..	18612	19 Oct. ..	95	24 Nov.
Cheese-press, Pressure appliance for ..	J. Anderson .. ..	18651	20 Oct. ..	95	24 Nov.
Churn .. ..	H. J. Baker .. ..	18554	6 Oct. ..	86	27 Oct.*
Churn and butter-worker .. ..	F. Richardson and F. Markey ..	18857	14 Dec. ..	..	..
Cigar and cigarette holder, Mouthpiece for ..	C. Peterson .. ..	17838	27 April ..	91	10 Nov.
Cistern .. ..	A. Taylor .. ..	18676	26 Oct. ..	91	10 Nov.*
Cistern. (See also Deodorizing-cistern, Flushing-cistern.)					
Clamp for wire rope .. ..	A. E. Gill .. ..	18893	24 Dec. ..	6	26 Jan., 1905.
Cleaner, Knife and fork .. ..	D. Simpson .. ..	18711	3 Nov. ..	95	24 Nov.*
Closet. (See Water-closet.)					
Clothes-peg .. ..	H. J. Whitelaw .. ..	17581	27 Feb. ..	102	22 Dec.
Clothes-strainer, &c. .. ..	P. Davis .. ..	18621	20 Oct. ..	95	24 Nov.
Coat-hanger .. ..	H. A. Collins .. ..	18539	4 Oct. ..	91	10 Nov.
Coat and trouser hanger .. ..	C. Lashlie .. ..	18756	16 Nov. ..	95	24 Nov.*
Coiler, Wire- .. ..	J. F. Ross and W. Wiggins ..	18876	20 Dec. ..	..	..
Coin-controlled machine .. ..	R. Wales .. ..	18251	28 July ..	102	22 Dec.
Coin-freed franking and stamping machine	C. E. Gray and J. S. Tolman ..	17386	17 Dec., 1903	86	27 Oct.
Collar and hames .. ..	S. J. Emery .. ..	18622	20 Oct. ..	91	10 Nov.*
Compressed-air pump .. ..	D. W. Starrett .. ..	18698	3 Nov. ..	6	26 Jan., 1905.
Concentrator-trough .. ..	E. J. Swyny and S. G. Plucknett	18585	13 Oct. ..	91	10 Nov.
Consumption cure .. ..	J. Pugh .. ..	18697	3 Nov. ..	95	24 Nov.*
Controller, Ship- .. ..	E. Smethurst .. ..	17606	1 March ..	102	22 Dec.
Cooking-stove, Gas-burner for .. ..	J. D. Jackson .. ..	18687	3 Nov. ..	91	10 Nov.*
Cooler, Milk- .. ..	C. J. Honore .. ..	18753	16 Nov. ..	98	8 Dec.
Cork-retainer for bottles .. ..	J. A. Gaynor .. ..	18709	4 Nov. ..	95	24 Nov.*
Cork-seal .. ..	G. S. Stevenson .. ..	18534	30 Sept. ..	86	27 Oct.*
Cotton-picking machine .. ..	G. A. Lowry .. ..	18743	15 Nov. ..	98	8 Dec.
Couch .. ..	W. Hoyland .. ..	17512	4 Feb. ..	98	8 Dec.
Coupling. (See Hose-coupling.)					
Cover of preserving-tin, Securing ..	Christchurch Meat Company, Limited	18456	16 Sept. ..	91	10 Nov.*
Cover. (See Cream-can cover, Horse-cover, Tire-cover.)					
Cow-bail .. ..	C. T. Simpson .. ..	18908	31 Dec. ..	3	12 Jan., 1905.*
Cow-bail .. ..	F. J. Brown .. ..	18867	16 Dec. ..	102	22 Dec.*
Cow-milker .. ..	F. Ljungström .. ..	17489	20 Jan. ..	91	10 Nov.
Cramp. (See Match-lining cramp.)					
Crate. (See Folding crate.)					
Cream-can cover .. ..	J. Hedley .. ..	18746	15 Nov. ..	98	8 Dec.
Cream product and manufacture .. ..	E. Phillips .. ..	18630	20 Oct. ..	..	..
Cream-testing flask .. ..	A. L. Horniman and A. Dawson ..	18819	1 Dec. ..	3	12 Jan., 1905.
Cricket. (See Table-cricket.)					
Cricket-stumps .. ..	A. Bridge .. ..	18485	22 Sept. ..	86	27 Oct.

## ALPHABETICAL LIST OF INVENTIONS—continued.

Invention.	Name.	Application.		Gazette.	
		No.	Date.	No.	Date.
Cuff-protector .. .. .	C. W. Ziele .. .. .	18677	28 Oct. ..	95	24 Nov.*
Culinary utensil .. .. .	F. E. Hornidge .. .. .	18712	8 Nov. ..	98	8 Dec.
Cultivator .. .. .	W. B. Jones .. .. .	18705	7 Nov. ..	95	24 Nov.*
Cup. (See Teat-cup.)					
Curing-mixture for food .. .. .	D. McCallum .. .. .	18733	11 Nov. ..	95	24 Nov.*
Current-collector .. .. .	W. Griffiths and B. H. Bedell .. .. .	18723	10 Nov. ..	98	8 Dec.
Curtain-hook .. .. .	T. Hemming and J. Lock .. .. .	18574	6 Oct. ..	86	27 Oct.*
Curtain-poles .. .. .	A. Marr .. .. .	18758	14 Nov. ..	..	..
Curtain-suspender .. .. .	G. Barnes .. .. .	18820	1 Dec. ..	3	12 Jan., 1905.*
Cushion heel for boots .. .. .	J. R. Skinner .. .. .	17402	22 Dec., 1903	86	27 Oct.
Cutter. (See Butter-cutter, Chaff-cutter, Tobacco-cutter, Twitch-cutter, Weed-cutter.)					
Cyanide ore-extraction solutions, Recovering gold, &c., from .. .. .	F. A. Rich .. .. .	18638	18 Oct. ..	95	24 Nov.
Cycle-motor .. .. .	M. Ruddy .. .. .	18802	29 Nov. ..	98	8 Dec.*
Cycle. (See also Bicycle.)					
Deck-chair .. .. .	A. H. Krause .. .. .	18882	19 Dec. ..	6	26 Jan., 1905.*
Deodorizing-cistern .. .. .	C. Woodford .. .. .	18809	1 Dec. ..	98	8 Dec.*
Departure and arrival indicator, Train .. .. .	H. Ashworth .. .. .	18762	18 Nov. ..	98	8 Dec.*
Die for cake-tins, &c. .. .. .	G. H. Clapham and J. L. Barlow .. .. .	17595	1 March ..	102	22 Dec.
Digger, Potato- .. .. .	J. G. Dennison .. .. .	18774	21 Nov. ..	98	8 Dec.*
Disinfectant, Fluid .. .. .	C. Woodford .. .. .	18809	1 Dec. ..	98	8 Dec.*
Disc ridger .. .. .	F. Cooper .. .. .	18660	25 Oct. ..	91	10 Nov.*
Docking and ear-marking instrument .. .. .	J. Dignan .. .. .	18767	17 Nov. ..	98	8 Dec.*
Door, Operating lift- .. .. .	W. F. Johns .. .. .	18613	19 Oct. ..	91	10 Nov.*
Door-lock .. .. .	A. G. Baker .. .. .	17965	26 May ..	102	22 Dec.
Drawers, Furniture .. .. .	G. S. Stevenson .. .. .	18533	30 Sept. ..	86	27 Oct.*
Draught-regulator for grate .. .. .	B. J. Mouat .. .. .	18515	24 Sept. ..	91	10 Nov.
Draught-regulator .. .. .	W. Sinclair .. .. .	18763	18 Nov. ..	98	8 Dec.*
Dredge-bucket .. .. .	H. R. Butterworth .. .. .	18895	22 Dec. ..	3	12 Jan., 1905.*
Dredge-ladder attachment .. .. .	W. Nisbet .. .. .	18873	19 Dec. ..	102	22 Dec.*
Drill. (See Maize-drill, Rock-drill.)					
Drying clothes, Machine for washing and .. .. .	P. M. Newton .. .. .	18755	14 Nov. ..	98	8 Dec.
Drying Milk .. .. .	A. Falkner .. .. .	18551	5 Oct. ..	86	27 Oct.*
Ear-marking instrument .. .. .	J. Dignan .. .. .	18767	17 Nov. ..	98	8 Dec.*
Ear-punch .. .. .	A. H. Tinkham .. .. .	18685	2 Nov. ..	95	24 Nov.
Earth-elevator .. .. .	H. Symes .. .. .	18605	14 Oct. ..	91	10 Nov.
Earthenware goods, Flanging .. .. .	R. O. Clark, jun. .. .. .	18898	23 Dec. ..	3	12 Jan., 1905.*
Earthenware pipes, Flanging .. .. .	R. O. Clark, jun. .. .. .	17182	30 Oct. 1903	86	27 Oct.
Egg-carrier .. .. .	E. L. Robertson .. .. .	18907	30 Dec. ..	3	12 Jan., 1905.*
Egg-carrier .. .. .	F. G. Norton .. .. .	18570	7 Oct. ..	86	27 Oct.*
Egg-carrier .. .. .	G. Finn and A. S. Pike .. .. .	18795	28 Nov. ..	102	22 Dec.
Egg-carrier .. .. .	G. Finn and A. S. Pike .. .. .	18680	1 Nov. ..	91	10 Nov.*
Egg-carrier .. .. .	J. G. Dawson .. .. .	18382	27 Aug. ..	95	24 Nov.
Egg-carrier .. .. .	R. Simmonds .. .. .	18739	14 Nov. ..	95	24 Nov.*
Egg-preserving process .. .. .	H. E. McDonald .. .. .	18702	4 Nov. ..	95	24 Nov.*
Egg-tester .. .. .	J. B. Waters .. .. .	18658	24 Oct. ..	91	10 Nov.*
Eggs for transport, Packing .. .. .	A. and F. J. Lawrence .. .. .	17273	19 Nov., 1903	83	13 Oct.
Electric arc lamp .. .. .	H. Beck .. .. .	18512	28 Sept. ..	91	10 Nov.
Electric belt .. .. .	J. W. Fowler .. .. .	18888	23 Dec. ..	..	..
Electric belt .. .. .	W. C. Watson and E. I. Setchell .. .. .	18694	31 Oct. ..	..	..
Electric cars, Illuminating trolley-wheel of .. .. .	W. H. Ludford .. .. .	18540	4 Oct. ..	86	27 Oct.*
Electric light, Applying, to pianos, &c. .. .. .	W. R. J. Townsend .. .. .	18553	5 Oct. ..	86	27 Oct.*
Electric switch .. .. .	W. Kingsland .. .. .	18856	14 Dec. ..	3	12 Jan., 1905.
Electric traction, Current-collector for .. .. .	W. Griffiths and B. H. Bedell .. .. .	18723	10 Nov. ..	98	8 Dec.
Electric traction, Trolley-pole for .. .. .	J. W. Rooney .. .. .	18786	24 Nov. ..	98	8 Dec.*
Elevator and deliverer .. .. .	G. Armstrong .. .. .	18775	21 Nov. ..	102	22 Dec.
Elevator, Safety appliance for .. .. .	W. P. Conolly .. .. .	18511	29 Sept. ..	91	10 Nov.
Elevator. (See also Earth-elevator.)					
Engine. (See Air-engine, Internal-combustion engine, Rock-drilling engine, Rotary turbine-engine, Traction-engine.)					
Envelope .. .. .	D. Robertson .. .. .	18558	3 Oct. ..	86	27 Oct.*
Envelope .. .. .	D. Robertson .. .. .	18708	4 Nov. ..	95	24 Nov.*
Envelope .. .. .	D. Robertson .. .. .	18836	3 Dec. ..	102	22 Dec.*
Envelope and memo-forms .. .. .	J. Collins .. .. .	18627	20 Oct. ..	91	10 Nov.*
Escape. (See Fire-escape)					
Excavating and elevating wash-dirt .. .. .	A. McKay .. .. .	18750	16 Nov. ..	95	24 Nov.*
Extinguisher. (See Fire-extinguisher, Gas lighter and extinguisher.)					
Eye-bath, bottle-stopper, and measure .. .. .	G. W. Darvall .. .. .	18602	17 Oct. ..	91	10 Nov.*
Fastener. (See Belt-fastener, Boot-fastener, Leg-fastener, Sash-fastener.)					
Fastening. (See Hook-and-eye fastening.)					
"Falls," Gate-post .. .. .	J. H. Smith and W. M. Alexander .. .. .	18469	22 Sept. ..	86	27 Oct.
Fatty wood, Treating, for the production of paper .. .. .	W. Hoskins .. .. .	18500	28 Sept. ..	86	27 Oct.
Faucet .. .. .	J. Fisher, jun. .. .. .	18580	13 Oct. ..	86	27 Oct.*



ALPHABETICAL LIST OF INVENTIONS—continued.

Invention.	Name.	Application.		Gazette.	
		No.	Date.	No.	Date.
Feed reservoir and box for horses ..	J. A. Easton .. ..	17398	18 Dec., 1903	91	10 Nov.
Feeding-bottle protector .. ..	J. Ellen .. ..	18900	29 Dec. ..	3	12 Jan., 1905.*
Fencing-dropper .. ..	C. E. H. Allen .. ..	18700	3 Nov. ..	..	..
Fencing-post .. ..	R. Thomas and G. Hall .. ..	18331	15 Aug. ..	86	27 Oct.
Fencing-standard, Preventing sinking of ..	A. Dale .. ..	18810	26 Nov. ..	98	8 Dec.*
Fencing-staple .. ..	G. Chewings .. ..	17501	29 Jan. ..	91	10 Nov.
Fencing-staple .. ..	A. J. Malcolm .. ..	18789	23 Nov. ..	3	12 Jan., 1905.*
Fencing-strainer .. ..	J. J. Ward .. ..	18785	24 Nov. ..	98	8 Dec.*
Filaments, Manufacturing .. ..	W. R. Whitney .. ..	18503	28 Sept. ..	86	27 Oct.
Filter. (See Slimes-filter.)					
Fire-alarm .. ..	J. Gallagher .. ..	17996	4 June ..	102	22 Dec.
Fire-bridge .. ..	C. J. Johnson and J. Carlaw .. ..	18865	14 Dec. ..	102	22 Dec.*
Fire-escape .. ..	H. Smith and L. Homes .. ..	18560	5 Oct. ..	86	27 Oct.*
Fire-extinguisher .. ..	J. G. Grimsley .. ..	18632	20 Oct. ..	95	24 Nov.
Fire-lighter .. ..	J. H. T. Turnbull .. ..	18738	8 Nov. ..	95	24 Nov.*
Fire-proof structures .. ..	W. W. Bruce .. ..	18740	8 Nov. ..	102	22 Dec.
Flanging-machine for earthenware .. ..	R. O. Clark, jun. .. ..	18898	23 Dec. ..	3	12 Jan., 1905.*
Flanging sanitary pipes .. ..	L. Clark .. ..	17105	13 Oct. ..	86	27 Oct.*
Flask. (See Cream-testing flask.)					
Flat-wick lamp-burner .. ..	E. E. Wagstaff .. ..	18797	25 Nov. ..	102	22 Dec.
Flax cleaner and conveyor .. ..	D. J. Williams .. ..	18877	20 Dec. ..	6	26 Jan., 1905.*
Flax-dressing, Process for .. ..	J. D. Smith .. ..	18565	5 Oct. ..	86	27 Oct.*
Flax-dresser .. ..	A. L. J. Tait .. ..	18601	17 Oct. ..	86	27 Oct.*
Flax drying and bleaching .. ..	D. C. Macdonald .. ..	18641	21 Oct. ..	91	10 Nov.*
Flax-milling machinery .. ..	H. Seifert .. ..	18619	13 Oct. ..	91	10 Nov.
Flax-scutching .. ..	G. I. Lowe .. ..	17371	15 Dec., 1903	83	13 Oct.
Flax, Treating .. ..	S. E. Denniston .. ..	17287	25 Nov., 1903	86	27 Oct.
Flax-treatment .. ..	C. Suttie and M. H. Wynyard .. ..	18917	31 Dec. ..	6	26 Jan., 1905.*
Flax-washer .. ..	G. Craw .. ..	18561	7 Oct. ..	86	27 Oct.*
Flax-washer .. ..	A. F. Gibson .. ..	18787	22 Nov. ..	102	22 Dec.*
Flax. (See also Tow.)					
Fluid-pressure turbine .. ..	E. T. Pollard .. ..	18879	20 Dec. ..	3	12 Jan., 1905.*
Flushing cistern, Liquid feed for .. ..	J. Hayward .. ..	18583	13 Oct. ..	91	10 Nov.
Folding crate .. ..	O. T. Wills .. ..	18840	6 Dec. ..	102	22 Dec.*
Folding-machine for newspapers, &c. .. ..	J. M. Twomey .. ..	18552	5 Oct. ..	86	27 Oct.*
Food-warming apparatus .. ..	H. Schnitzer .. ..	17422	30 Dec., 1903	83	13 Oct.
Fork-cleaner. (See Knife and fork cleaner.)					
Franking-machine, Coin-freed .. ..	C. E. Gray and J. S. Tolman .. ..	17386	17 Dec., 1903	86	27 Oct.
Friction-clutch .. ..	J. F. Wilson .. ..	18764	18 Nov. ..	98	8 Dec.*
Fruit-carrier .. ..	R. Simmonds .. ..	18739	14 Nov. ..	95	24 Nov.*
Fruit-case .. ..	R. F. Thomas and S. A. Bradley .. ..	18715	10 Nov. ..	98	8 Dec.*
Fuel-burner, Liquid .. ..	A. E. Johnstone .. ..	18721	10 Nov. ..	98	8 Dec.
Furnace, Blower for .. ..	H. T. Jones and J. P. Ludeman .. ..	18883	22 Dec. ..	..	..
Furnace. (See Ironsand-furnace, Ore-furnace.)					
Furniture drawers .. ..	G. S. Stevenson .. ..	18533	30 Sept. ..	86	27 Oct.*
Game .. ..	J. H. Rowland .. ..	18492	24 Sept. ..	86	27 Oct.
Game .. ..	H. Brice .. ..	17460	13 Jan. ..	91	10 Nov.
Game .. ..	C. H. Waddle and S. White .. ..	17478	15 Jan. ..	98	8 Dec.
Game .. ..	E. L. Evens .. ..	18817	1 Dec. ..	3	12 Jan., 1905.
Garment-lacing .. ..	N. Le R. Tracy .. ..	18811	28 Nov. ..	98	8 Dec.*
Gas-burner for bath-heater, cooking-stove, &c. .. ..	J. D. Jackson .. ..	18687	3 Nov. ..	91	10 Nov.*
Gas-generator .. ..	H. Dicke .. ..	18728	10 Nov. ..	95	24 Nov.*
Gas, Producing .. ..	W. Sim .. ..	18760	8 Nov. ..	95	24 Nov.*
Gas. (See also Incandescent gas, Water-gas.)					
Gas lighter and extinguisher .. ..	M. W. Haenke .. ..	18661	27 Oct. ..	95	24 Nov.
Gas lighter and extinguisher .. ..	J. L. Bruce .. ..	18722	10 Nov. ..	98	8 Dec.
Gas-stove .. ..	J. J. Strain .. ..	18828	3 Dec. ..	3	12 Jan., 1905.
Gate-post "falls" .. ..	J. H. Smith and W. M. Alexander .. ..	18469	22 Sept. ..	86	27 Oct.
Gauge. (See Wind-gauge.)					
Generator. (See Acetylene-generator, Gas-generator.)					
Glass, Manufacture of sheet .. ..	Window-glass Machine Company .. ..	18837	2 Dec. ..	3	12 Jan., 1905.
Gold and silver, Recovery of .. ..	F. A. Rich .. ..	18638	18 Oct. ..	95	24 Nov.
Gold-saving .. ..	J. Paterson and A. T. W. Allan .. ..	18777	18 Nov. ..	98	8 Dec.*
Gold-saving appliance .. ..	A. J. Park .. ..	18896	22 Dec. ..	3	12 Jan., 1905.*
Gold-saving apparatus .. ..	A. Johanson .. ..	18832	3 Dec. ..	102	22 Dec.*
Gold-saving apparatus .. ..	J. W. McLeod .. ..	18590	14 Oct. ..	91	10 Nov.*
Gold-saving plush .. ..	M. Ryan .. ..	18576	11 Oct. ..	91	10 Nov.*
Gold-saving table .. ..	H. N. McLeod .. ..	18782	22 Nov. ..	98	8 Dec.*
Gold-saving, Raking material from sluice-boxes used in .. ..	G. Dennis, jun. .. ..	17519	6 Feb. ..	98	8 Dec.
Gold, Separation of, from metals .. ..	D. Clark .. ..	18538	4 Oct. ..	86	27 Oct.*
Governor-gear for traction-engine .. ..	E. F. and E. H. C. Ridder .. ..	18901	29 Dec. ..	3	12 Jan., 1905.*
Grain and wild-oats separator .. ..	A. C. Wilson and J. C. McDonald .. ..	18833	3 Dec. ..	102	22 Dec.*
Grate, Regulating draught for .. ..	B. J. Mouat .. ..	18515	24 Sept. ..	91	10 Nov.
Guard. (See Moustache-guard, Mud-guard.)					
Gun, Vernier and traversing-bar for ladder of .. ..	G. B. H. Austin .. ..	18453	15 Sept. ..	86	27 Oct.*

## ALPHABETICAL LIST OF INVENTIONS—continued.

Invention.	Name.	Application.		Gazette.	
		No.	Date.	No.	Date.
Hair-pin .. .. .	A. M. Hendy .. .. .	18897	22 Dec. ..	..	..
Hair-pin .. .. .	W. A. McKay and J. H. Cobb .. .. .	18862	15 Dec. ..	102	22 Dec.*
Hames and collar .. .. .	S. J. Emery .. .. .	18622	20 Oct. ..	91	10 Nov.*
Hammock-support .. .. .	Globe Proprietary Company, Limited	18647	22 Oct. ..	95	24 Nov.
Handle, Axe- .. .. .	H. Harding .. .. .	18892	24 Dec. ..	3	12 Jan., 1905.*
Handle to bakers' peel, Attaching	J. C. Legg .. .. .	18829	3 Dec. ..	..	..
Hanger. (See Coat-hanger.)					
Harness, Breeching arrangement for	R. D. Kelly .. .. .	18773	21 Nov. ..	98	8 Dec.*
Harness saddle .. .. .	G. B. and A. Edwards and W. Wetenhall	18894	29 Dec. ..	3	12 Jan., 1905.*
Harrow and twitch-cutter .. .. .	R. McGregor .. .. .	18588	10 Oct. ..	86	27 Oct.*
Harrow, Rotary tine .. .. .	A. Dahl .. .. .	18843	5 Dec. ..	..	..
Hat .. .. .	C. B. and G. W. Plummer	18675	29 Oct. ..	91	10 Nov.*
Hay-knife .. .. .	J. Hunt .. .. .	18727	10 Nov. ..	..	..
Hay-knife .. .. .	H. H. Gilshnan .. .. .	18595	15 Oct. ..	91	10 Nov.*
Hay-stacking appliance .. .. .	J. Gemmell .. .. .	17607	27 Feb. ..	102	22 Dec.
Heater. (See Bath-heater.)					
Heel. (See Boot-heel.)					
Heel-trimming, &c., machine .. .. .	United Shoe Machinery Company	18751	16 Nov. ..	95	24 Nov.*
Hoe .. .. .	T. Walker .. .. .	18842	7 Dec. ..	102	22 Dec.*
Holder. (See Cigar and cigarette holder, Pen-holder, Rein-holder, Trace-holder.)					
Hook-and-eye fastening .. .. .	E. Sprey and F. Spray .. .. .	18568	7 Oct. ..	95	24 Nov.*
Hook, Curtain- .. .. .	T. Hemming and J. Lock .. .. .	18574	6 Oct. ..	86	27 Oct.*
Horse-cover .. .. .	W. Trembath .. .. .	17667	16 March ..	102	22 Dec.
Horse-shoe .. .. .	J. Grant .. .. .	18562	7 Oct. ..	..	..
Horse-stopper and wheel-lock .. .. .	T. Firth .. .. .	17446	9 Jan. ..	95	24 Nov.
Hose-coupling .. .. .	P. Henley .. .. .	18726	10 Nov. ..	95	24 Nov.*
Hurdle. (See Racing-hurdle.)					
Hydrocyanic-acid manufacture .. .. .	H. C. Woltreck .. .. .	18803	29 Nov. ..	102	22 Dec.
Images, Photographing, to obtain abnormal pictures .. .. .	E. M. McLauchlan .. .. .	18550	5 Oct. ..	86	27 Oct.*
Incandescent gas-burner .. .. .	C. J. Alexander .. .. .	18853	13 Dec. ..	..	..
Incandescent gaslight .. .. .	J. Warry and P. Wigley .. .. .	18737	18 July† ..	95	24 Nov.*
Incandescent oil-lamp .. .. .	C. Jerome .. .. .	18696	3 Nov. ..	95	24 Nov.*
Incubator, Temperature-regulator for .. .. .	R. Law .. .. .	18692	3 Nov. ..	98	8 Dec.
Indicator. (See Railway indicator, Temperature-indicator.)					
Insecticide-sprayer .. .. .	J. Eckersley .. .. .	18549	5 Oct. ..	86	27 Oct.*
Internal-combustion engine .. .. .	D. Roberts, C. James, and J. W. Young	18633	20 Oct. ..	95	24 Nov.
Internal-combustion engine .. .. .	W. Dawson .. .. .	18695	31 Oct. ..	98	8 Dec.
Invert work, Centres for .. .. .	P. Cairns .. .. .	18650	22 Oct. ..	91	10 Nov.*
Iron, Manufacture of .. .. .	C. F. Lungley .. .. .	16975	5 Aug., 1903†	83	13 Oct.
Iron-ore, Reducing pulverised .. .. .	J. H. A. McPhee .. .. .	18490	20 Sept. ..	86	27 Oct.
Ironsand briquettes .. .. .	J. T. Hunter .. .. .	18707	7 Nov. ..	6	26 Jan., 1905.
Ironsand briquettes .. .. .	T. Rouse and H. Cohn .. .. .	18905	29 Dec. ..	3	12 Jan., 1905.*
Ironsand-furnace .. .. .	W. G. Cloke .. .. .	18734	11 Nov. ..	95	24 Nov.*
Jack. (See Lifting-jack.)					
Joints, Making, in pipes .. .. .	J. Christie .. .. .	18532	30 Sept. ..	86	27 Oct.*
Kegs, Machine for rounding, &c. .. .. .	J. Russell .. .. .	18603	17 Oct. ..	86	27 Oct.*
Key. (See Bullock-bow key, Screw-key, Telegraphic signalling-key.)					
Knife. (See Hay-knife, Thinning and weeding knife.)					
Knife and fork cleaner .. .. .	D. Simpson .. .. .	18711	3 Nov. ..	95	24 Nov.*
Knife and fork cleaner .. .. .	C. Broadhead and T. Harris	18824	3 Dec. ..	98	8 Dec.*
Lacing garments, &c. .. .. .	N. L. R. Tracy .. .. .	18811	28 Nov. ..	98	8 Dec.*
Ladder and frame for rifle .. .. .	G. B. H. Austin .. .. .	18620	20 Oct. ..	91	10 Nov.*
Lamp. (See Electric arc lamp, Incandescent oil-lamp, Oil-lamp, Signal-lamp.)					
Lamp-burner .. .. .	E. E. Wagstaff .. .. .	18797-8	25 Nov. ..	102	22 Dec.
Lamp-burner thimble .. .. .	E. E. Wagstaff .. .. .	18799	25 Nov. ..	102	22 Dec.
Laundry apparatus .. .. .	C. Robertson .. .. .	17440	7 Jan. ..	102	22 Dec.
Lead-pencil .. .. .	H. Mitchell .. .. .	18646	18 Oct. ..	91	10 Nov.*
Leg-fastener for animals .. .. .	H. Prince .. .. .	18543	4 Oct. ..	91	10 Nov.
Leg-roping appliance .. .. .	F. J. Brown .. .. .	18868	16 Dec. ..	102	22 Dec.*
Level. (See Spirit-level.)					
Lid for culinary utensil .. .. .	F. E. Hornidge .. .. .	18712	8 Nov. ..	98	8 Dec.
Lift-door, Operating .. .. .	W. F. Johns .. .. .	18613	19 Oct. ..	91	10 Nov.*
Lifting-jack .. .. .	A. Dyke .. .. .	18717	7 Nov. ..	95	24 Nov.*
Lifter, Ambulance .. .. .	J. Mackay and F. W. Hamilton	16927	21 Oct. ..	86	27 Oct.*
Light, Electric, applying to pianos	W. R. J. Townsend .. .. .	18553	5 Oct. ..	86	27 Oct.*
Lighter. (See Fire-lighter, Gas-lighter.)					
Liner for separator .. .. .	J. A. Ohlsson .. .. .	18884	22 Dec. ..	..	..
Liner for washing-boiler .. .. .	H. W. de Baugh .. .. .	18890	21 Dec. ..	..	..
Liquid-fuel burner .. .. .	A. E. Johnstone .. .. .	18721	10 Nov. ..	98	8 Dec.

ALPHABETICAL LIST OF INVENTIONS—continued.

Invention.	Name.	Application.		Gazette.	
		No.	Date.	No.	Date.
Liquid or fluid pump .. .. .	Positive Rotary Pump, Limited	18599	13 Oct. ..	91	10 Nov.
Liquids, Machine for bottling .. .. .	The Crown Corporation, Limited	18579	13 Oct. ..	3	12 Jan., 1905.
Lithographic copy .. .. .	J. H. Fuller .. .. .	18792	23 Nov. ..	98	8 Dec.*
Lithographic plate .. .. .	F. W. Sears .. .. .	17685	22 March ..	98	8 Dec.
Lock (See Bicycle-lock, Door-lock, Sash raiser and lock, Strap-lock, Wheel-lock.)					
Magnetic separator .. .. .	J. T. Dawes .. .. .	18769	17 Nov. ..	102	22 Dec.
Maize-drill .. .. .	F. A. Pim .. .. .	18846	8 Dec. ..	102	22 Dec.*
Mantle-support .. .. .	The New Inverted Incandescent Gas-lamp Company, Limited ..	18326	17 Aug. ..	98	8 Dec.
Manure-sower .. .. .	A. Scherer .. .. .	18742	15 Nov. ..	95	24 Nov.*
Match-box and tobacco-cutter .. .. .	W. F. Dugins .. .. .	18629	20 Oct. ..	95	24 Nov.
Match-lining cramp .. .. .	F. E. Newth .. .. .	18606	18 Oct. ..	91	10 Nov.*
Match-making .. .. .	The Dixie Match Company	18730	10 Nov. ..	98	8 Dec.
Mattress, Wire-woven .. .. .	T. J. A. Hicks and R. F. Way ..	18454	15 Sept. ..	86	27 Oct.*
Measure, bottle-stopper, and eye-bath ..	G. W. Darvall .. .. .	18602	17 Oct. ..	91	10 Nov.*
Measuring and wringing machine for skins	O. Gemeinhardt .. .. .	18505	28 Sept. ..	86	27 Oct.
Memo.-form and envelope .. .. .	J. Collins .. .. .	18627	20 Oct. ..	91	10 Nov.*
Metal-finishing process .. .. .	A. H. R. Allen and H. S. Darley	18748	16 Nov. ..	95	24 Nov.*
Metallic bedstead .. .. .	B. C. Barton .. .. .	17465	13 Jan. ..	86	27 Oct.
Metals, Producing, from ores .. .. .	J. S. M. Jacobsen .. .. .	18909	31 Dec. ..	..	..
Milk-aerator .. .. .	R. J. Moore .. .. .	17514	4 Feb. ..	98	8 Dec.
Milk-can .. .. .	A. W. Gillies .. .. .	18834	5 Dec. ..	102	22 Dec.*
Milk-can .. .. .	D. Bower .. .. .	18770	18 Nov. ..	98	8 Dec.*
Milk-cooler .. .. .	C. J. Honore .. .. .	18753	16 Nov. ..	98	8 Dec.
Milk-drying .. .. .	A. Falkner .. .. .	18551	5 Oct. ..	86	27 Oct.*
Milk-powder .. .. .	A. Glas .. .. .	18720	10 Nov. ..	..	..
Milk, Process of treating .. .. .	E. Phillips .. .. .	18598	13 Oct. ..	91	10 Nov.
Milk-stirrer .. .. .	W. E. Toxward and D. G. Monrad	18768	19 Nov. ..	98	8 Dec.*
Milker, Cow-.. .. .	F. Ljungström .. .. .	17489	20 Jan. ..	91	10 Nov.
Milker, Cow-.. .. .	J. Hartnett and D. M. Robison ..	18303	11 Aug. ..	102	22 Dec.
Milking-machine .. .. .	T. C. Jenkins and W. T. Mack ..	18839	6 Dec. ..	3	12 Jan., 1905.
Mineral matter and tar, Manufacture of articles from	S. Ford and J. S. Freeman ..	18614	19 Oct. ..	91	10 Nov.*
Mineral particles from slimes, Extracting	E. J. Swyny and S. G. Plucknett	18586	13 Oct. ..	91	10 Nov.
Mineral-wool making .. .. .	F. T. Paten .. .. .	18587	13 Oct. ..	86	27 Oct.*
Mining-machine .. .. .	W. E. Hamilton .. .. .	18504	28 Sept. ..	86	27 Oct.
Mop-wringing attachment to bucket ..	J. Herrick .. .. .	18716	10 Nov. ..	98	8 Dec.*
Mop-wringing attachment to bucket ..	G. Stevenson .. .. .	18889	23 Dec. ..	3	12 Jan., 1905.*
Motion, Utilising resistance of .. .. .	A. Strain .. .. .	18683	1 Nov. ..	95	24 Nov.*
Motor. (See Wind and water motor, Cycle-motor.)					
Moulding-boards, Forming .. .. .	A. Falkner .. .. .	18555	6 Oct. ..	91	10 Nov.
Moustache-guard for spoons, &c. .. .	G. G. Sutherland, and A. G. Brett	17559	23 Feb. ..	102	22 Dec.
Mouthpiece for tobacco-pipe .. .. .	C. Peterson .. .. .	17838	27 April ..	91	10 Nov.
Mud-guard for vehicle .. .. .	H. Munro .. .. .	18596	15 Oct. ..	..	..
Music-leaf turner .. .. .	G. F. Moyle .. .. .	18559	4 Oct. ..	86	27 Oct.*
Music-teaching method .. .. .	C. E. Gibbins .. .. .	18845	5 Dec. ..	102	22 Dec.*
Nail, Roofing- .. .. .	W. J. Templeton .. .. .	18814	1 Dec. ..	..	..
Nail-driving machine .. .. .	United Shoe Machinery Company	18752	16 Nov. ..	95	24 Nov.*
Nailing-machine .. .. .	United Shoe Machinery Company	18625	20 Oct. ..	95	24 Nov.
Needle, Sewing-machine .. .. .	E. J. Hall .. .. .	18808	1 Dec. ..	3	12 Jan., 1905.
Newspaper-folding machine .. .. .	J. M. Twomey .. .. .	18552	5 Oct. ..	86	27 Oct.*
Non-refillable stopper .. .. .	W. Madder .. .. .	18823	3 Dec. ..	3	12 Jan., 1905.*
Noxious weeds, Composition for eradication of	E. D. Smith and J. T. Partridge..	18678	29 Oct. ..	91	10 Nov.*
Numbering and recording machine .. .. .	C. B. Smith .. .. .	18920	29 Dec. ..	..	..
Number-recording machine .. .. .	H. Droullege .. .. .	18594	11 Oct. ..	91	10 Nov.
Nuts and bolts, Screw-key for .. .. .	S. McDonald and G. S. Stevenson	18801	29 Nov. ..	..	..
Oil-lamp for railway signals .. .. .	The Lamp Manufacturing Company, Limited	18861	13 Dec. ..	..	..
Oiling-appliance for machinery .. .. .	T. Danks .. .. .	18826	1 Dec. ..	3	12 Jan., 1905.
Open-air treatment of disease, Health shelter for	A. W. Bickerton .. .. .	17522	5 Feb. ..	98	8 Dec.
Ore-furnace .. .. .	W. P. Wynne and J. H. Grant ..	18838	6 Dec. ..	102	22 Dec.
Ore-furnace .. .. .	T. Edwards .. .. .	18878	21 Dec. ..	..	..
Ore, Production of metals from .. .. .	J. S. M. Jacobsen .. .. .	18909	31 Dec. ..	..	..
Ore, Reducing iron- .. .. .	J. H. A. McPhee .. .. .	18490	20 Sept. ..	86	27 Oct.
Ore-separator .. .. .	A. J. F. de Bavay .. .. .	18688	3 Nov. ..	91	10 Nov.*
Ore separator and classifier .. .. .	E. J. Swyny and S. G. Plucknett	18584	13 Oct. ..	91	10 Nov.
Ore-separator. (See also Magnetic separator.)					
Ore-treatment .. .. .	A. Z. Clark .. .. .	18818	1 Dec. ..	3	12 Jan., 1905.
Organ, Applying electric light to .. .. .	W. R. J. Townsend .. .. .	18553	5 Oct. ..	86	27 Oct.*
Oven, Bakers' .. .. .	M. Richard and W. Scott .. .. .	18531	29 Sept. ..	91	10 Nov.
Overcoat .. .. .	D. Matheson .. .. .	18667	28 Oct. ..	91	10 Nov.*
Packing butter .. .. .	J. M. Hussey .. .. .	18858	14 Dec. ..	3	12 Jan., 1905.
Packing-case .. .. .	Champion Seal Company .. .. .	18813	1 Dec. ..	3	12 Jan., 1905.
Packing eggs for transport .. .. .	A. and F. J. Lawrence .. .. .	17273	19 Nov. 1903	83	13 Oct.

ALPHABETICAL LIST OF INVENTIONS—*continued.*

Invention.	Name.	Application.		Gazette.	
		No.	Date.	No.	Date.
Paddle apparatus, Boat- .. ..	W. A. White .. ..	18665	25 Oct. ..	..	..
Panel work, Forming .. ..	A. Falkner .. ..	18555	6 Oct. ..	91	10 Nov.
Panoramic camera .. ..	W. J. Johnston .. ..	18783	24 Nov. ..	102	22 Dec.
Paper health shelter .. ..	A. W. Bickerton .. ..	17522	5 Feb. ..	98	8 Dec.
Paper-pulp, Treating fatty wood for production of .. ..	W. Hoskins .. ..	18500	28 Sept. ..	86	27 Oct.
Parcel-carrier .. ..	E. S. Baldwin and H. H. Rayward .. ..	18875	20 Dec. ..	..	..
Peel. (See Bakers' peel.) .. ..					
Peeler. (See Potato-peeler.) .. ..					
Penholder .. ..	E. M. Palmer .. ..	18604	18 Oct. ..	..	..
Pencil. (See Lead-pencil.) .. ..					
Petroleum-burner .. ..	J. C. C. Read .. ..	18634	20 Oct. ..	91	10 Nov.*
Piano, Applying electric light to .. ..	W. R. J. Townsend .. ..	18553	5 Oct. ..	86	27 Oct. *
Piano-player, Valve for .. ..	E. J. Thwaites .. ..	18581	13 Oct. ..	86	27 Oct. *
Picture-suspender .. ..	W. E. S. Ramsay and S. McMurray .. ..	17480	20 Jan. ..	95	24 Nov.
Pictures, Obtaining abnormal .. ..	E. M. McLauchlan .. ..	18550	5 Oct. ..	86	27 Oct.*
Piles, Treating, to prevent teredo worm .. ..	J. Rutland .. ..	18563	8 Oct. ..	..	..
Pin. (See Hair-pin, Safety-pin.) .. ..					
Pipe-moulding machine .. ..	P. Campbell .. ..	18529	27 Sept. ..	91	10 Nov.
Pipe-wrench .. ..	J. Adams and C. A. Cross .. ..	18530	27 Sept. ..	91	10 Nov.
Pipe. (See Earthenware pipe, Sanitary pipe, Tobacco-pipe.) .. ..					
Pipe, Making joints in .. ..	J. Christie .. ..	18532	30 Sept. ..	86	27 Oct.*
Pithing-spear .. ..	F. H. Andrews .. ..	18591	14 Oct. ..	86	27 Oct.*
Plant-pot .. ..	W. T. London .. ..	18830	3 Dec. ..	3	12 Jan., 1905.
Plate-rack .. ..	F. V. Raymond .. ..	18854	10 Dec. ..	102	22 Dec.
Plate, Rail-bed .. ..	H. Read .. ..	18567	7 Oct. ..	86	27 Oct.
Player, Valve for piano- .. ..	E. J. Thwaites .. ..	18581	13 Oct. ..	86	27 Oct.*
Plush for gold-saving .. ..	M. Ryan .. ..	18576	11 Oct. ..	91	10 Nov.*
Pneumatic tire .. ..	W. H. Paterson .. ..	18860	12 Dec. ..	102	22 Dec. *
Pneumatic-tire protector .. ..	A. McLean .. ..	18564	8 Oct. ..	86	27 Oct.*
Pocket .. ..	T. A. and J. Flynn .. ..	18831	3 Dec. ..	3	12 Jan., 1905.
Polisher, Boot- .. ..	P. A. S. Stephens .. ..	18761	14 Nov. ..	98	8 Dec.*
Pole. (See Curtain-pole.) .. ..					
Post. (See Fencing-post, Gate-post.) .. ..					
Postage-stamp vending machine .. ..	R. J. Dickie and J. H. Brown .. ..	18548	5 Oct. ..	86	27 Oct.*
Postal wrapper .. ..	A. Matheson .. ..	18699	3 Nov. ..	95	24 Nov.
Pot, Plant- .. ..	W. T. London .. ..	18830	3 Dec. ..	3	12 Jan., 1905.
Potato-digger .. ..	J. G. Dennison .. ..	18774	21 Nov. ..	98	8 Dec.*
Potato-peeler .. ..	W. M. Norrie .. ..	18869	16 Dec. ..	102	22 Dec.*
Potato-tops, Destroying blight on .. ..	W. S. Campbell .. ..	18765	14 Nov. ..	98	8 Dec.*
Pounding-up machine .. ..	United Shoe Machinery Company .. ..	18626	20 Oct. ..	91	10 Nov.*
Preserve-can .. ..	H. Böhm .. ..	18624	20 Oct. ..	..	..
Preserving eggs .. ..	H. E. McDonald .. ..	18702	4 Nov. ..	95	24 Nov.*
Preserving-tin, Securing top of .. ..	Christchurch Meat Company, Limited .. ..	18456	16 Sept. ..	91	10 Nov.*
Press. (See Cheese-press.) .. ..					
Printing-block, Plate for .. ..	F. W. Sears .. ..	17685	22 March ..	98	8 Dec.
Propelling-apparatus for bicycles, &c. .. ..	W. S. Simpson .. ..	18623	20 Oct. ..	95	24 Nov.
Protector. (See Boot-sole protector, Candle-protector, Cuff-protector, Feeding-bottle protector, Tire-protector.) .. ..					
Puller, Turnip- .. ..	P. and D. Duncan, Limited .. ..	18571	8 Oct. ..	86	27 Oct.*
Pump. (See Compressed-air pump, Liquid or fluid pump, Spray-pump, Water-pump.) .. ..					
Punch, Ear- .. ..	A. H. Tinkham .. ..	18685	2 Nov. ..	95	24 Nov.
Race for sheep .. ..	C. Bask and E. A. Cameron .. ..	18899	23 Dec. ..	3	12 Jan., 1905.*
Racing-hurdle .. ..	H. P. Knutzen, W. A. Elwarth, and G. R. Buscke .. ..	18575	7 Oct. ..	95	24 Nov.*
Rack. (See Plate-rack.) .. ..					
Rails, Dressing surfaces of .. ..	M. Woods and T. J. Gilbert .. ..	18537	30 Sept. ..	91	10 Nov.
Rail-bed plate .. ..	H. Reed .. ..	18567	7 Oct. ..	86	27 Oct.
Railway brake .. ..	F. W. Gasmier .. ..	18501	28 Sept. ..	86	27 Oct.
Railway car .. ..	A. R. Angus .. ..	18714	8 Nov. ..	..	..
Railway indicator .. ..	H. Ashworth .. ..	18762	18 Nov. ..	98	8 Dec.*
Railway-sleeper, Compound for protection of .. ..	S. Ford and J. S. Freeman .. ..	18526	1 Oct. ..	86	27 Oct.*
Rain-water collector .. ..	L. Adamson .. ..	18754	16 Nov. ..	102	22 Dec.
Rake .. ..	J. Dunbar .. ..	18645	17 Oct. ..	91	10 Nov.*
Range-finder for rifle shooting .. ..	R. H. Owen .. ..	18670	28 Oct. ..	91	10 Nov.*
Receptacle for perishable goods .. ..	C. P. Parkerson .. ..	18608	18 Oct. ..	91	10 Nov.*
Recording and numbering machine .. ..	C. B. Smith .. ..	18920	29 Dec. ..	..	..
Reducing fuel-consumption of vessel .. ..	T. Ashcroft .. ..	18701	1 Nov. ..	95	24 Nov.*
Reflecting-apparatus, advertising-medium .. ..	R. L. H. Murray .. ..	18600	13 Oct. ..	..	..
Register, Cash- .. ..	E. G. Fletcher .. ..	18611	19 Oct. ..	95	24 Nov.
Registering and number-recording machine .. ..	H. Droutlege .. ..	18594	11 Oct. ..	91	10 Nov.
Regulator. (See Draught-regulator, Temperature-regulator.) .. ..					
Rein-holder .. ..	A. Dyke .. ..	18719	7 Nov. ..	95	24 Nov.*
Ridger, Disc .. ..	F. Cooper .. ..	18660	25 Oct. ..	91	10 Nov.*
Ridging .. ..	T. C. Hement .. ..	18793	26 Nov. ..	98	8 Dec.*
Ridging .. ..	C. S. Hawkeswood .. ..	17541	11 Feb. ..	98	8 Dec.

ALPHABETICAL LIST OF INVENTIONS—continued.

Invention.	Name.	Application.		Gazette.	
		No.	Date.	No.	Date.
Ridging, Forming sheet-iron .. ..	T. C. Hement .. ..	18557	4 Oct. ..	86	27 Oct.*
Rifle, Ladder and frame for .. ..	G. B. H. Austin .. ..	18620	20 Oct. ..	91	10 Nov.*
Rifle shooting, Range-finder for ..	R. H. Owen .. ..	18670	28 Oct. ..	91	10 Nov.*
Rifle-sight .. ..	H. J. Paddock .. ..	18664	27 Oct. ..	..	..
Rifle-sight, Fixing spirit-level to ..	G. B. H. Austin .. ..	18521	29 Sept. ..	91	10 Nov.*
Rifle, Vernier and traversing-bar for ladder of	G. B. H. Austin .. ..	18453	15 Sept. ..	86	27 Oct.*
Rifle vernier, Ventometer for fixing spirit- level to	G. B. H. Austin .. ..	18546	4 Oct. ..	86	27 Oct.*
Rock-drill .. ..	W. C. Johnson and G. C. Pearson	18610	19 Oct. ..	91	10 Nov.*
Rock-drilling engine .. ..	F. L. Roudebush .. ..	18827	1 Dec. ..	3	12 Jan., 1905.
Rod. (See Stair-rod, Wheel-rod.)					
Roll, Buffing- .. ..	United Shoe Machinery Company	17453	12 Jan. ..	86	27 Oct.
Roller for wire-gauze screen .. ..	J. M. Sibbit .. ..	18519	29 Sept. ..	91	10 Nov.*
Roofing, Fixing corrugated-iron .. ..	J. W. Wrigley .. ..	18654	25 Oct. ..	95	24 Nov.
Roofing-tile and ridging .. ..	C. S. Hawkeswood .. ..	17541	11 Feb. ..	98	8 Dec.
Roofing-nail .. ..	W. J. Templeton .. ..	18814	1 Dec. ..	..	..
Rotary scraping-board .. ..	C. E. Horman .. ..	18757	16 Nov. ..	..	..
Rotary turbine engine, Steam-exhaust for	T. W. May .. ..	18766	14 Nov. ..	98	8 Dec.*
Saddle .. ..	G. B. and A. Edwards and W. Wetenhall	18894	29 Dec. ..	3	12 Jan., 1905.*
Saddle-tree .. ..	R. A. C. Russell .. ..	18388	26 March† ..	102	22 Dec.
Safety appliance for elevator .. ..	W. P. Conolly .. ..	18511	29 Sept. ..	91	10 Nov.
Safety-pin .. ..	G. G. Turri .. ..	18852	13 Dec. ..	3	12 Jan., 1905.
Sanitary pipes flanging .. ..	L. Clark .. ..	17105	13 Oct., 1903	86	27 Oct.
Sash-fastener .. ..	F. Stowell .. ..	18589	10 Oct. ..	91	10 Nov.*
Sash for window .. ..	W. H. Terry .. ..	18616	18 Oct. ..	91	10 Nov.*
Sash for window, Reversible .. ..	F. de J. Clere .. ..	18674	29 Oct. ..	91	10 Nov.*
Sash-lock .. ..	J. Wiseman .. ..	17293	26 Nov. ..	102	22 Dec.
Sash raiser and lock .. ..	A. L. Hewton .. ..	18547	1 Oct. ..	95	24 Nov.
Sash-suspender .. ..	A. J. Park .. ..	17447	9 Jan. ..	98	8 Dec.
Sash. (See also Window-sash.)					
Scraping-attachment for brush .. ..	H. Ward .. ..	18397	31 Aug. ..	91	10 Nov.
Scraping-board, Rotary .. ..	C. E. Horman .. ..	18757	16 Nov. ..	..	..
Screen, Roller for wire-gauze .. ..	J. M. Sibbit .. ..	18519	29 Sept. ..	91	10 Nov.*
Screw-key for nuts and bolts .. ..	S. McDonald and G. S. Stevenson	18801	29 Nov. ..	..	..
Scutcher. (See Flax-scutcher.)					
Scutching-attachment, Water .. ..	H. Seifert .. ..	17819	20 April ..	83	13 Oct.
Seal, Cork- .. ..	G. S. Stevenson .. ..	18534	30 Sept. ..	86	27 Oct. *
Seal or stopper .. ..	Champion Seal Company	18816	1 Dec. ..	..	12 Jan., 1905.
Seat. (See Vehicle-seat, Chair-seat.)					
Seed-sower .. ..	J. King .. ..	18784	24 Nov. ..	..	..
Separator, Liner for .. ..	J. A. Ohlsson .. ..	18884	22 Dec. ..	..	..
Separator. (See Grain and wild-oats separator, Magnetic separator, Ore- separator.)					
Sewing-machine .. ..	E. A. Angus .. ..	18693	3 Nov. ..	98	8 Dec.
Sewing-machine needle .. ..	E. J. Hall .. ..	18808	1 Dec. ..	3	12 Jan., 1905.
Shaft-bearings .. ..	E. R. Smith .. ..	18885	22 Dec. ..	6	26 Jan., 1905.
Shaft, securing to vehicle .. ..	J. T. Rodgers .. ..	18673	25 Oct. ..	91	10 Nov. *
Shaft-stop .. ..	W. S. Grant .. ..	18566	6 Oct. ..	86	27 Oct.*
Shaft. (See Vehicle-shaft.)					
Shaving-brush .. ..	G. Koch .. ..	18478	22 Sept. ..	86	27 Oct.*
Sheaves-conveyor .. ..	J. Orr, jun. .. ..	18771	19 Nov. ..	98	8 Dec.*
Sheep, &c., Travelling-race for .. ..	C. Rask and E. A. Cameron	18899	23 Dec. ..	3	12 Jan., 1905.*
Sheet-glass manufacture .. ..	Window-glass Machine Company	18837	2 Dec. ..	3	12 Jan., 1905.
Shelter. (See Paper health shelter.)					
Ship-controller .. ..	E. Smethurst .. ..	17606	1 March ..	102	22 Dec.
Shoe. (See Boot or shoe, Horse-shoe.)					
Sight. (See Rifle-sight.)					
Signal-lamp .. ..	The Lamp Manufacturing Com- pany, Limited	18861	13 Dec. ..	6	26 Jan., 1905.
Signalling-key, Telegraphic .. ..	Marconi's Wireless Telegraph Com- pany, Limited	18725	10 Nov. ..	98	8 Dec.
Siphon .. ..	H. Corbett .. ..	18662	27 Oct. ..	91	10 Nov.*
Skewers, &c., Manufacturing .. ..	W. J. Sellars .. ..	17379	16 Dec., 1903	95	24 Nov.
Skin measurer and wringer .. ..	O. Gemeinhardt .. ..	18505	28 Sept. ..	86	27 Oct.
Skirt and blouse support .. ..	M. Bacon .. ..	18776	17 Nov. ..	3	12 Jan., 1905.
Slags for making mineral wool, Producing Sleeper. (See Railway-sleeper.)	F. T. Paten .. ..	18587	13 Oct. ..	86	27 Oct.*
Slimes, Extracting mineral particles from	E. J. Swyny and S. G. Plucknett	18586	13 Oct. ..	91	10 Nov.
Slimes-filter .. ..	H. R. Cassel .. ..	17600	2 March ..	102	22 Dec.
Sluice-box, Raking material from ..	G. Dennis, jun. .. ..	17519	6 Feb. ..	98	8 Dec.
Smoke-consumer .. ..	H. Gunn .. ..	18850	6 Dec. ..	3	12 Jan., 1905.*
Smoke-consumer .. ..	C. J. Johnson and J. Carlaw	18865	14 Dec. ..	102	22 Dec.*
Smoke-destroyer for furnace .. ..	A. H. Byron .. ..	18747	12 Nov. ..	95	24 Nov.*
Snatch-block, Releasable .. ..	J. Ducker, jun. .. ..	18542	4 Oct. ..	86	27 Oct.*
Sole. (See Boot-sole.)					
Sole laying and levelling machine ..	United Shoe Machinery Company	18690	3 Nov. ..	91	10 Nov.*
Sower. (See Manure-sower, Seed-sower, Turnip and rape sower.)					
Spear, Pitbing- .. ..	F. H. Andrews .. ..	18591	14 Oct. ..	86	27 Oct.*

ALPHABETICAL LIST OF INVENTIONS—*continued.*

Invention.	Name.	Application.		Gazette.	
		No.	Date.	No.	Date.
Speed of vessel, Increasing .. ..	T. Asheroft .. ..	18701	1 Nov. ..	95	24 Nov.*
Spiles, &c., Manufacturing .. ..	W. J. Sellars .. ..	17379	16 Dec., 1903	95	24 Nov.
Spirit-level, Fixing, to rifle-sight .. ..	G. B. H. Austin .. ..	18521	29 Sept. ..	91	10 Nov.*
Spoons, Moustache-guard for .. ..	G. G. Sutherland and A. G. Brett	17559	23 Feb. ..	102	22 Dec.
Spouting-bracket .. ..	F. Wilkinson .. ..	18704	5 Nov. ..	95	24 Nov.*
Spouting, Forming O.G. .. ..	T. C. Hement .. ..	18528	1 Oct. ..	83	13 Oct.*
Spray-pump, Agitator for .. ..	A. Billens .. ..	18659	25 Oct. ..	95	24 Nov.
Spreader for traces .. ..	B. Gibbs .. ..	18657	26 Oct. ..	98	8 Dec.
Spreader for trace-chains .. ..	J. Holms, jun. .. ..	18452	12 Sept. ..	102	22 Dec.
Spring-equalising apparatus for vehicles..	C. E. Bailey .. ..	18541	4 Oct. ..	86	27 Oct.*
Stacking-appliance .. ..	J. Gemmell .. ..	17607	27 Feb. ..	102	22 Dec.
Stair-rod .. ..	G. W. Basley .. ..	18891	22 Dec. ..	3	12 Jan., 1905.*
Stair-rod, Securing .. ..	E. S. Smith .. ..	18703	4 Nov. ..	..	..
Stamp-vending machine .. ..	R. J. Dickie and J. H. Brown ..	18548	5 Oct. ..	86	27 Oct.*
Stamping-machine, Coin-freed .. ..	C. E. Gray and J. S. Tolman ..	17386	17 Dec., 1903	86	27 Oct.
Stand. (See Bicycle-stand.)					
Staple. (See Fencing-staple.)					
Steam-exhaust .. ..	T. W. May .. ..	18766	14 Nov. ..	98	8 Dec.*
Steam-turbine .. ..	H. C. Henderson .. ..	18592	14 Oct. ..	91	10 Nov.*
Steam-turbine .. ..	J. C. Fraser .. ..	18864	12 Dec. ..	102	22 Dec.
Steel, Manufacture of .. ..	C. F. Lungley .. ..	16975	5 Aug., 1903	83	13 Oct.
Stirrer, Milk- .. ..	W. E. Toxward and D. G. Monrad	18768	19 Nov. ..	98	8 Dec.
Stopper. (See Bottle-stopper, Horse-stopper, Seal or stopper, Non-refillable stopper.)					
Stove. (See Cooking-stove, Gas-stove.)					
Strainer .. ..	A. McDonald and S. R. Stedman	18871	16 Dec. ..	102	22 Dec.*
Strainer. (See Clothes-strainer, Fencing-strainer, Wire-strainer.)					
Strap-lock .. ..	H. Kitchin and A. Patten ..	18569	7 Oct. ..	86	27 Oct.*
Strap. (See Breeching-strap.)					
Street-scavenger .. ..	G. B. B. Elliott .. ..	18880	21 Dec. ..	..	..
Stretcher, Woven-wire .. ..	E. Grundy .. ..	18577	11 Oct. ..	95	24 Nov.*
Stumps, Cricket- .. ..	A. Bridge .. ..	18485	22 Sept. ..	86	27 Oct.
Support. (See Hammock-support, Skirt and blouse support.)					
Surgical instrument for use on cattle ..	C. Brake .. ..	18656	24 Oct. ..	95	24 Nov.
Suspender. (See Curtain-suspender, Picture-suspender.)					
Swath-turner .. ..	E. C. Blackstone and R. E. Watts	18804	29 Nov. ..	102	22 Dec.
Swingletree, Trace-holder for .. ..	A. Dyke .. ..	18718	7 Nov. ..	95	24 Nov.*
Switch, Electric .. ..	W. Kingsland .. ..	18856	14 Dec. ..	3	12 Jan., 1905.
Table. (See Billiard-table, Bowl-testing table, Gold-saving table, Time-table.)					
Table-amusement .. ..	C. H. Waddle and S. White ..	17478	15 Jan. ..	98	8 Dec.
Table-cricket .. ..	H. Brice .. ..	17460	13 Jan. ..	91	10 Nov.
Tailings, &c., Extraction of mineral particles from .. ..	E. J. Swyny and S. G. Plucknett..	18586	13 Oct. ..	91	10 Nov.
Tap .. ..	A. Burt .. ..	18643	19 Oct. ..	91	10 Nov.*
Tap for tins .. ..	H. S. Clark .. ..	18874	16 Dec. ..	..	..
Tar and mineral matter, Manufacture of articles from compounds of .. ..	S. Ford and J. S. Freeman ..	18614	19 Oct. ..	91	10 Nov.*
Teat-cup, Pneumatic .. ..	A. Gillies .. ..	17639	9 March ..	83	13 Oct.
Telegraphic signalling-key .. ..	Marconi's Wireless Telegraph Company, Limited	18724	10 Nov. ..	98	8 Dec.
Telegraph. (See also Wireless telegraph.)					
Telescope .. ..	C. Soulas .. ..	17496	25 Jan. ..	95	24 Nov.
Telemeter .. ..	A. Hare .. ..	18887	23 Dec. ..	3	12 Jan., 1905.*
Temperature-indicator .. ..	J. Gallagher .. ..	17996	4 June ..	102	22 Dec.
Temperature-regulator for incubator ..	R. Law .. ..	18692	3 Nov. ..	98	8 Dec.
Teredo worm, Preventing attack of, in wooden piles .. ..	J. Rutland .. ..	18563	8 Oct. ..	..	..
Tester. (See Egg-tester, Bowl-tester.)					
Testing. (See Ball-testing, Bowl-testing, Cream-testing.)					
Thimble. (See Lamp-burner thimble.)					
Thinning and weeding knife .. ..	A. Lowe .. ..	18910	31 Dec. ..	6	26 Jan., 1905.
Threshing-machine, Conveying sheaves from stacks to .. ..	J. Orr, jun. .. ..	18771	19 Nov. ..	98	8 Dec.*
Ticket-vending machine .. ..	R. J. Dickie and J. H. Brown ..	18548	5 Oct. ..	86	27 Oct.*
Tile. (See Roofing-tile.)					
Timber veneer, Repairing defects in ..	A. McColl .. ..	18652	21 Oct. ..	91	10 Nov.*
Time-table advertising-device .. ..	W. J. Rae .. ..	18749	16 Nov. ..	..	..
Tin. (See Preserving-tin.)					
Tins, Tap for .. ..	H. S. Clark .. ..	18874	16 Dec. ..	..	..
Tip road-wagon .. ..	F. Cooper .. ..	18732	10 Nov. ..	95	24 Nov.*
Tire-cover .. ..	E. Burchett .. ..	18781	22 Nov. ..	98	8 Dec.*
Tire for cycle, &c. .. ..	J. J. Daily .. ..	18336	18 Aug. ..	95	24 Nov.
Tire, Pneumatic .. ..	P. Magnus .. ..	18631	20 Oct. ..	95	24 Nov.
Tire-protector .. ..	A. McLean .. ..	18564	8 Oct. ..	86	27 Oct.*
Tire, Vehicle- .. ..	J. Thomson .. ..	18791	24 Nov. ..	98	8 Dec.*
Tire, Vehicle- .. ..	T. P. Lyons .. ..	17579	26 Feb. ..	102	22 Dec.

ALPHABETICAL LIST OF INVENTIONS—continued.

Invention.	Name.	Application.		Gazette.	
		No.	Date.	No.	Date.
Tobacco-cutter .. .. .	D. G. Sutherland .. .. .	18851	12 Dec. ..	102	22 Dec.*
Tobacco-cutter .. .. .	W. F. Dugins .. .. .	18629	20 Oct. ..	95	24 Nov.
Tobacco-pipe .. .. .	W. F. Dugins .. .. .	18628	20 Oct. ..	95	24 Nov.
Tobacco-pipe, Mouthpiece for .. .. .	C. Peterson .. .. .	17838	27 April ..	91	10 Nov.
Tow cleaning and sorting method .. .. .	E. Elliott and A. J. Park .. .. .	18545	14 Nov. ..	102	22 Dec.
Trace-holder .. .. .	A. Dyke .. .. .	18718	7 Nov. ..	95	24 Nov.*
Trace-spreader. (See Spreader.) .. .. .					
Traction-engine governor-gear .. .. .	E. F. and E. H. C. Ridder .. .. .	18901	29 Dec. ..	3	12 Jan., 1905.*
Trap. (See Bird-trap, Water-closet trap.) .. .. .					
Trolley-pole .. .. .	J. W. Rooney .. .. .	18786	24 Nov. ..	98	8 Dec.*
Trolley-wheel of electric cars, Illuminating .. .. .	W. H. Ludford .. .. .	18540	4 Oct. ..	86	27 Oct.*
Trough. (See Concentrator-trough.) .. .. .					
Trouser-hanger. (See Coat and trouser hanger.) .. .. .					
Truck .. .. .	R. McKay .. .. .	18759	14 Nov. ..	95	24 Nov.*
Tug-stop for shafts .. .. .	H. W. Candy .. .. .	18744	15 Nov. ..	95	24 Nov.*
Turbine. (See Fluid-pressure turbine, Rotary turbine, Steam-turbine.) .. .. .					
Turnip and rape feed .. .. .	E. E. Porter .. .. .	18618	19 Oct. ..	91	10 Nov.*
Turnip and rape sower .. .. .	D. Moore .. .. .	18556	3 Oct. ..	86	27 Oct.*
Turnip and rape sower .. .. .	J. King .. .. .	18784	24 Nov. ..	3	12 Jan., 1905.*
Turnip-puller .. .. .	P. and D. Duncan, Limited .. .. .	18571	8 Oct. ..	86	27 Oct.*
Turpentine, Treating fatty wood for production of .. .. .	W. Hoskins .. .. .	18500	28 Sept. ..	86	27 Oct.
Twine, Binder- .. .. .	A. and W. Ross .. .. .	18642	21 Oct. ..	95	24 Nov.
Twitch-cutter and harrow .. .. .	R. McGregor .. .. .	18588	10 Oct. ..	86	27 Oct.*
Union joints, Method of making .. .. .	J. Christie .. .. .	18532	30 Sept. ..	86	27 Oct.*
Valve .. .. .	W. C. Nixon and M. J. Jones .. .. .	18593	11 Oct. ..	95	24 Nov.
Valve, Pneumatic, for piano-player .. .. .	E. J. Thwaites .. .. .	18581	13 Oct. ..	86	27 Oct.*
Valve, Operating, at predetermined time .. .. .	A. Hare .. .. .	18886	23 Dec. ..	3	12 Jan., 1905.*
Vehicle mud-guard .. .. .	H. Munro .. .. .	18596	15 Oct. ..	..	..
Vehicle .. .. .	S. G. Whitehouse .. .. .	18429	2 Sept. ..	91	10 Nov.
Vehicle-seat .. .. .	J. H. Toner .. .. .	18780	19 Nov. ..	98	8 Dec.*
Vehicle-seat slide .. .. .	W. E. Searle and W. Gibb .. .. .	18735	8 Nov. ..	95	24 Nov.*
Vehicle, Securing shaft to .. .. .	J. T. Rodgers .. .. .	18673	25 Oct. ..	91	10 Nov.*
Vehicle-shaft, Securing breeching-strap to .. .. .	J. Brake .. .. .	17629	7 March ..	95	24 Nov.
Vehicle, Spring-equalising apparatus for .. .. .	C. E. Bailey .. .. .	18541	4 Oct. ..	86	27 Oct.*
Vehicle-wheel .. .. .	J. Thomson .. .. .	18791	24 Nov. ..	98	8 Dec.*
Veneer. (See Timber veneer.) .. .. .					
Ventilating-window .. .. .	W. E. Walker .. .. .	18644	19 Oct. ..	91	10 Nov.*
Vernier ventometer for rifle .. .. .	G. B. H. Austin .. .. .	18546	4 Oct. ..	86	27 Oct.*
Vessel, Reducing fuel-consumption of .. .. .	T. Ashcroft .. .. .	18701	1 Nov. ..	95	24 Nov.*
Wagon, Tip road- .. .. .	F. Cooper .. .. .	18732	10 Nov. ..	95	24 Nov.*
Warming apparatus, Food-, &c. .. .. .	H. Schnitzer .. .. .	17422	30 Dec., 1903	83	13 Oct.
Wash-dirt excavating and elevating .. .. .	A. McKay .. .. .	18750	16 Nov. ..	95	24 Nov.*
Washing-apparatus for wool .. .. .	H. Ashworth .. .. .	18573	10 Oct. ..	91	10 Nov.
Washing and drying machine .. .. .	P. M. Newton .. .. .	18755	14 Nov. ..	98	8 Dec.
Washing machine, Flax- .. .. .	A. F. Gibson .. .. .	18787	22 Nov. ..	102	22 Dec.*
Washing-machine .. .. .	R. F. Marsh .. .. .	17988	1 June ..	86	27 Oct.
Washing-boiler, Liner for .. .. .	H. W. de Baugh .. .. .	18890	21 Dec. ..	..	..
Water-collector. (See Rain-water collector.) .. .. .					
Water-closet trap, Jointing .. .. .	C. E. Denmead and F. J. Mahoney .. .. .	18636	19 Oct. ..	6	26 Jan., 1905.
Water-gas production .. .. .	J. T. Hunter .. .. .	18729	10 Nov. ..	95	24 Nov.*
Water-pump .. .. .	B. G. A. Harkness .. .. .	18572	10 Oct. ..	86	27 Oct.*
Water scutching-attachment .. .. .	H. Seifert .. .. .	17819	20 April ..	83	13 Oct.
Water-tube boiler .. .. .	J. Smaill .. .. .	18597	14 Oct. ..	91	10 Nov.*
Weatherboards .. .. .	F. de J. Clere .. .. .	18682	1 Nov. ..	91	10 Nov.*
Weed-cutter .. .. .	W. Moses .. .. .	18617	19 Oct. ..	91	10 Nov.*
Weed-eradicator .. .. .	V. Karl .. .. .	18866	16 Dec. ..	102	22 Dec.*
Weed-eradicator .. .. .	H. Donkin .. .. .	18794	28 Nov. ..	..	..
Weed-eradicator .. .. .	E. D. Smith and J. T. Partridge .. .. .	18678	29 Oct. ..	91	10 Nov.*
Weed-eradicator .. .. .	G. Henderson, jun. .. .. .	18835	5 Dec. ..	..	..
Weed-eradicator .. .. .	E. G. A. Hille .. .. .	18807	29 Nov. ..	98	8 Dec.*
Weed-eradicator .. .. .	G. Henderson .. .. .	18872	22 Dec. ..	..	..
Weeding-knife. (See Thinning and weeding knife.) .. .. .					
Welt-operating machine .. .. .	United Shoe Machinery Company .. .. .	18691	3 Nov. ..	91	10 Nov.*
Wheel-lock and horse-stopper .. .. .	T. Firth .. .. .	17446	9 Jan. ..	95	24 Nov.
Wheel-rod .. .. .	A. McDonald and S. R. Stedman .. .. .	17099	10 Oct., 1903	91	10 Nov.
Wheel. (See also Trolley-wheel, Vehicle-wheel.) .. .. .					
Wild-oats and grain separator .. .. .	A. C. Wilson and J. C. McDonald .. .. .	18833	3 Dec. ..	102	22 Dec.
Wind and water motor .. .. .	L. T. Reichel .. .. .	18640	21 Oct. ..	91	10 Nov.*
Wind-gauge for rifle .. .. .	G. B. H. Austin .. .. .	18546	4 Oct. ..	86	27 Oct.*
Wind-gauge sight for rifle .. .. .	H. J. Paddock .. .. .	18664	27 Oct. ..	..	..
Windmill .. .. .	T. Danks .. .. .	18825	1 Dec. ..	3	12 Jan., 1905.
Window .. .. .	W. Edwards and T. Larsen .. .. .	18578	11 Oct. ..	3	12 Jan., 1905.
Window-sash .. .. .	F. de J. Clere .. .. .	18674	29 Oct. ..	91	10 Nov.*
Window-sash .. .. .	W. H. Terry .. .. .	18616	18 Oct. ..	91	10 Nov.*

## ALPHABETICAL LIST OF INVENTIONS—continued.

Invention.	Name.	Application.		Gazette.	
		No.	Date.	No.	Date.
Window-sash lock .. .. .	J. Wiseman .. .. .	17293	26 Nov., 1903	102	22 Dec.
Windows. (See also Anti-rattlers, Sash, Ventilating-window.)					
Wire-fence binder .. .. .	T. W. Coulthard .. .. .	18655	25 Oct. .. .. .	..	..
Wire coiler and uncoiler .. .. .	J. F. Ross and W. Wiggins .. .. .	18876	20 Dec. .. .. .	..	..
Wire-gauze screen, Roller for .. .. .	J. M. Sibbit .. .. .	18519	29 Sept. .. .. .	91	10 Nov.*
Wire rope, Clamp for .. .. .	A. E. Gill .. .. .	18893	24 Dec. .. .. .	6	26 Jan., 1905.
Wire-strainer .. .. .	W. Norris .. .. .	18844	5 Dec. .. .. .	3	12 Jan., 1905.
Wire-strainer .. .. .	F. M. Brewerton .. .. .	18788	25 Nov. .. .. .	..	..
Wire-strainer .. .. .	G. Ingram and C. E. Thompson .. .. .	18544	4 Oct. .. .. .	..	..
Wire-strainer, Reel .. .. .	J. Simmonds .. .. .	18790	23 Nov. .. .. .	3	12 Jan., 1905.
Wire-tightener .. .. .	J. J. Ward .. .. .	18785	24 Nov. .. .. .	98	8 Dec.*
Wireless-telegraph transmitter .. .. .	Marconi's Wireless Telegraph Company, Limited	18725	10 Nov. .. .. .	98	8 Dec.
Wireless-telegraph system .. .. .	H. Shoemaker .. .. .	18731	10 Nov. .. .. .	102	22 Dec.
Wire-woven mattress .. .. .	T. J. A. Hicks and R. F. Way .. .. .	18454	15 Sept. .. .. .	86	27 Oct.*
Wood, Treating fatty .. .. .	W. Hoskins .. .. .	18500	28 Sept. .. .. .	86	27 Oct.
Wood, Treating .. .. .	T. Gare .. .. .	18859	14 Dec. .. .. .	3	12 Jan., 1905.
Wool, Mineral, making .. .. .	F. T. Paten .. .. .	18587	13 Oct. .. .. .	86	27 Oct.*
Wool, Washing, &c. .. .. .	H. Ashworth .. .. .	18573	10 Oct. .. .. .	91	10 Nov.
Woven-wire stretcher .. .. .	E. Grundy .. .. .	18577	11 Oct. .. .. .	95	24 Nov.*
Wrapper. (See Postal wrapper.)					
Wrench. (See Pipe-wrench.)					
Wringing and measuring machine for skins	O. Gemeinhardt .. .. .	18505	28 Sept. .. .. .	86	27 Oct.
Writing-desk .. .. .	J. H. Fuller .. .. .	18792	23 Nov. .. .. .	98	8 Dec.*

## List of Applicants for Registration of Trade Marks.

**A** LPHABETICAL list of applicants for registration of trade marks for quarter ending 31st December, 1904 (including also applications lodged prior to but gazetted during such quarter).

Name.	Address.	Class.	Application.		Gazette.	
			No.	Date.	No.	Date.
Æolian Company, The .. .. .	New York, U. S. A. .. .. .	9	4733	25 May .. .. .	95	24 Nov.
Agricultural and Pastoral Food Company, Limited, The	Wellington, N.Z. .. .. .	42	5040, 1	25 Nov. .. .. .	98	8 Dec.
Agricultural and Pastoral Food Company, Limited, The	Wellington, N.Z. .. .. .	42	5046	1 Dec. .. .. .	98	8 Dec.
Aktiengesellschaft Vormals Seidel and Naumann	Dresden, Saxony .. .. .	6	5050	1 Dec. .. .. .	98	8 Dec.
Appleton, J. A., and another .. .. .	Sydney, N.S.W. .. .. .	1	4963	20 Oct. .. .. .	86	27 Oct.
Arkell and Douglas .. .. .	New York, U.S.A., and Sydney, N.S.W.	47	4958, 9	15 Oct. .. .. .	86	27 Oct.
Asiatic Petroleum Company, Limited, The	London, England .. .. .	47, 13	5034, 5	24 Nov. .. .. .	98	8 Dec.
Asiatic Petroleum Company, Limited, The	London, England .. .. .	47	5088	29 Dec. .. .. .	..	12 Jan., 1905.
Auckland Pure Food Company, The. (See E. C. Hadfield.)						
Australian Explosives and Chemical Company, Limited, The	Melbourne, Victoria .. .. .	2	5022	16 Nov. .. .. .	98	8 Dec.
Bailey, G. E. .. .. .	Christchurch, N.Z. .. .. .	42	5068	12 Dec. .. .. .	102	22 Dec.
Batkin, E. C. .. .. .	Wellington, N.Z. .. .. .	45	5000	8 Nov. .. .. .	95	24 Nov.
Bay of Plenty Co-operative Dairy Association, Limited	Te Puke, N.Z. .. .. .	42	5039	.. .. .	..	..
Beattie, Lang, and Co. .. .. .	Wellington, N.Z. .. .. .	42	5081	16 Dec. .. .. .	102	22 Dec.
Bock, and Co., P. .. .. .	Auckland, N.Z. .. .. .	3	5089	29 Dec. .. .. .	..	..
Bock, J. A. .. .. .	Auckland, N.Z. .. .. .	3	4938	28 Sept. .. .. .	95	24 Nov.
British Columbia Packers Association, The	Vancouver, B.C. .. .. .	42	4941	29 Sept. .. .. .	86	27 Oct.
British Columbia Packers Association, The	Vancouver, B.C. .. .. .	42	5004, 9	10 Nov. .. .. .	..	..
British Columbia Packers Association, The	Vancouver, B.C. .. .. .	42	5005-8, 5010	10 Nov. .. .. .	95	24 Nov.
British Columbia Packers Association, The	Vancouver, B.C. .. .. .	42	5011	10 Nov. .. .. .	102	22 Dec.
Browne Bros. and Geddes .. .. .	Auckland, N.Z. .. .. .	42	5020	14 Nov. .. .. .	95	24 Nov.
Buchanan, Limited, W. .. .. .	Auckland, N.Z. .. .. .	42	5057	3 Dec. .. .. .	98	8 Dec.
Bycroft, Limited .. .. .	Auckland, N.Z. .. .. .	42	4946	1 Oct. .. .. .	86	27 Oct.
California Fig Syrup Company (Inc.) .. .. .	San Francisco, U.S.A., and London, England	3	5030, 2	22 Nov. .. .. .	..	..
Carr and Son .. .. .	New Southgate, England	50	4512	12 Jan. .. .. .	91	10 Nov.
Chapman, Deekes, and Co., F. .. .. .	London, England .. .. .	13	5075	14 Dec. .. .. .	102	22 Dec.
Christie, A. .. .. .	Gore, N.Z. .. .. .	42	4957	14 Oct. .. .. .	91	10 Nov.
Chrystall and Co. (See Neill and Co., Limited.)						



ALPHABETICAL LIST OF APPLICANTS FOR REGISTRATION OF TRADE MARKS—*continued.*

Name.	Address.	Class.	Application.		Gazette.	
			No.	Date.	No.	Date.
Clarke, Nickolls, and Coombs, Limited	London, England ..	42	5043	29 Nov. ..	98	8 Dec.
Clarke, Nickolls, and Coombs, Limited	London, England ..	42	5044	29 Nov. ..	102	22 Dec.
Clay and Bock and Co., Limited, H.	London, England, and Havana, Cuba ..	45	5063-5	9 Dec. ..	102	22 Dec.
Clay and Bock and Co., Limited, H.	London, England, and Havana, Cuba ..	45	5085	22 Dec. ..	3	12 Jan., 1905.
Cowley, A., and another	London, England ..	42	5028	22 Nov. ..	102	22 Dec.
Cudby, G., and another	Lower Hutt, N.Z. ..	50	4949	4 Oct. ..	83	13 Oct.
Dally, E.	Masterton, N.Z. ..	42	5083	19 Dec. ..	6	26 Jan., 1905.
Dannevirke Woodware Manufacturing Company, The. (See A. L. Gordon and Co.)						
Davies and Fehon, Limited	Sydney, N.S.W. ..	47	5080	15 Dec. ..	102	22 Dec.
De Lisle, De B., and another	Gisborne, N.Z. ..	2	4608	15 March ..	95	24 Nov.
De Luen Bros.	Palmerston North, N.Z. ..	38	5036	24 Nov. ..	..	..
Dickinson, C.	Dunedin, N.Z. ..	45	4887	29 Aug. ..	86	27 Oct.
Durie and Co., A.	Dunedin, N.Z. ..	42	4994	4 Nov. ..	91	10 Nov.
Durie and Co., A.	Dunedin, N.Z. ..	42	5069	12 Dec. ..	102	22 Dec.
Electro-Silicon Company, The	New York, U.S.A. ..	50	4978	27 Oct. ..	91	10 Nov.
Espenhahn, E., and others	Sydney, N.S.W. ..	2	4966	21 Oct. ..	91	10 Nov.
Felton, Grimwade, and Co.	Melbourne, Victoria ..	42	4989	3 Nov. ..	91	10 Nov.
Finn, G., and another	Wellington, N.Z. ..	13	5012	10 Nov. ..	95	24 Nov.
Fletcher, Humphreys, and Co.	Christchurch, N.Z. ..	42	5045	1 Dec. ..	98	8 Dec.
Francis Chapman, Deekes, and Co.	London, England ..	13	5075	14 Dec. ..	102	22 Dec.
Fulford, G. T.	Brockville, Canada ..	3	4982	31 Oct. ..	91	10 Nov.
Giesen, W. B., and another	Wanganui, N.Z. ..	42	5078	15 Dec. ..	3	12 Jan., 1905.
Gilbert and Sons, J. B.	Wanganui, N.Z. ..	47	4961	17 Oct. ..	86	27 Oct.
Gilbert Machinery Company, Limited, The	Wellington, N.Z. ..	16, 47	5023, 4	16 Nov. ..	98	8 Dec.
Globe Proprietary, Limited, The	Auckland, N.Z. ..	7	5037	25 Nov. ..	..	..
Gordon and Co., A. L.	Dannevirke, N.Z. ..	50	5002	8 Nov. ..	..	..
Graham, R.	Pitlair, Scotland ..	42	4981	31 Oct. ..	91	10 Nov.
Green and Colebrook, Limited	Ngaruawahia, N.Z. ..	4972-4	4, 42, 47	22 Oct. ..	86	27 Oct.
Guthridge, Limited, N.	Wellington, N.Z. ..	50	4965	20 Oct. ..	86	27 Oct.
Gutta Percha and Rubber Manufacturing Company of Toronto, Limited, The	Toronto, Canada ..	38	5051	29 Nov. ..	..	..
Gutta Percha and Rubber Manufacturing Company of Toronto, Limited, The	Toronto, Canada ..	40, 50	5052, 3	29 Nov. ..	98	8 Dec.
Hadfield, E. C.	Auckland, N.Z. ..	42	4960	15 Oct. ..	91	10 Nov.
Hadfield, E. C.	Auckland, N.Z. ..	42	5015	12 Nov. ..	95	24 Nov.
Hannagan, F.	Opoho, N.Z. ..	3	4950	5 Oct. ..	..	..
Hawkes' Bay Co-operative Dairy Company, The. (See Beattie, Lang, and Co.)						
Hean, G. W.	Wanganui, N.Z. ..	3	4997, 8	7 Nov. ..	95	24 Nov.
Hennessy and Co., J.	Cognac, France ..	43	4967	21 Oct. ..	95	24 Nov.
Hennessy and Co., J.	Cognac, France ..	43	4968	21 Oct. ..	98	8 Dec.
Hennessy and Co., J.	Cognac, France ..	43	4969	21 Oct. ..	102	22 Dec.
Hennessy and Co., J.	Cognac, France ..	43	4970	21 Oct. ..	3	12 Jan., 1905.
Henry, W., and another	Lower Hutt, N.Z. ..	50	4949	4 Oct. ..	83	13 Oct.
Higgins, F. E.	Cambridge, N.Z. ..	3	5082	16 Dec. ..	102	22 Dec.
Histed, J. R., and another	London, England ..	42	5028	22 Nov. ..	102	22 Dec.
Holbrooks Limited	Birmingham, England ..	42	4991	3 Nov. ..	91	10 Nov.
Hutt Valley Timber Company, The. (See W. Henry and G. Cudby.)						
Hyde, A.	Te Awamutu, N.Z. ..	44	5001	8 Nov. ..	95	24 Nov.
Independent Starch Company	New York, U.S.A. ..	42	4873	17 Aug. ..	95	24 Nov.
Inglewood Co-operative Bacon-curing Company, Limited, The	Inglewood, N.Z. ..	42	5003	10 Nov. ..	95	24 Nov.
Inglis Bros. (See T. Inglis.)						
Inglis, T.	Wellington, N.Z. ..	6	5070	13 Dec. ..	3	12 Jan., 1905.
Inglis, T.	Wellington, N.Z. ..	13, 22, 40	5071-3	13 Dec. ..	102	22 Dec.
Ingram, G., and another	Lower Moutere, N.Z. ..	7	5021	14 Nov. ..	95	24 Nov.
Izard, W. A., and another	Wanganui, N.Z. ..	42	5078	15 Dec. ..	3	12 Jan., 1905.
Jones and Son, Limited, H. I.	Wanganui, N.Z. ..	39	4926	20 Sept. ..	86	27 Oct.
Jones, E. V.	Christchurch, N.Z. ..	42	5013	10 Nov. ..	95	24 Nov.
Keddie, J. H.	Greymouth, N.Z. ..	3	5067	9 Dec. ..	..	..
Kingsland, W. J.	New York, U.S.A. ..	50	4992	3 Nov. ..	91	10 Nov.
Kirkcaldie and Stains, Limited	Wellington and Napier, N.Z. ..	27	4948	3 Oct. ..	83	13 Oct.
Lennon, F. J.	Rockhampton, Q. ..	3	4928	22 Sept. ..	86	27 Oct.
Lever Bros., Limited	Balmain, N.S.W. ..	42	4914	15 Sept. ..	91	10 Nov.
Lever Bros., Limited	Balmain, N.S.W. ..	47, 48	4955, 6	13 Oct. ..	86	27 Oct.
Linde British Refrigeration Company, Limited, The	London, England ..	47	5031	22 Nov. ..	98	8 Dec.

## ALPHABETICAL LIST OF APPLICANTS FOR REGISTRATION OF TRADE MARKS—continued.

Name.	Address.	Class.	Application.		Gazette.	
			No.	Date.	No.	Date.
Lisle, de. (See under De.)						
Loopuyt, P.	Schiedam, Holland	43	5017	14 Nov.	98	8 Dec.
Loopuyt and Co., P. (See P. Loopuyt.)						
Luen, de. (See under De.)						
Luttrell, E. V., and another	Gisborne, N. Z.	2	4608	15 March	95	24 Nov.
Maling and Dixon. (See T. J. Maling.)						
Maling, T. J.	Christchurch, N.Z.	42	4953	10 Oct.	86	27 Oct.
Manson, H. J.	Palmerston North, N.Z.	7	4983	1 Nov.	91	10 Nov.
Marechal Ruchon and Co., Limited	London, England, and St. Claude & Paris, France	50	5059	6 Dec.	..	..
Marechal Ruchon and Co., Limited	London, England, and St. Claude & Paris, France	50	5060, 1	6 Dec.	98	8 Dec.
Marechal Ruchon and Co., Limited	London, England, and Paris, France	50	5090	29 Dec.	3	12 Jan., 1905.
Martial and Cie. (See J. R. Histed and A. Cowley.)						
Martin, F. L., and others	Sydney, N.S.W.	2	4966	21 Oct.	91	10 Nov.
Martin, V. E., and others	Sydney, N.S.W.	2	4966	21 Oct.	91	10 Nov.
McArthur, W. and A., South Africa, Limited	Sydney, N.S.W.	42	4935	28 Sept.	86	27 Oct.
McLeod and Co., C.	Napier, N.Z.	47	5055, 6	3 Dec.	98	8 Dec.
Me'da Proprietary	Wellington, N.Z.	3	4990	3 Nov.	3	12 Jan., 1905.
Middlemas, R.	London, England	45	4984	1 Nov.	91	10 Nov.
Minerva Motors, Limited	London, England	22	5029	22 Nov.	98	8 Dec.
Murias y Ca, J. S.	New York, U.S.A.	45	5066	9 Dec.	102	22 Dec.
Nathan and Co., Limited, J.	Wellington, N.Z.	42	4987	1 Nov.	95	24 Nov.
Nathan and Co., Limited, J.	Wellington, N.Z.	42	5014	10 Nov.	..	..
Neil, J. G.	Invercargill, N.Z.	2, 3	4976, 7	24 Oct.	91	10 Nov.
Neil and Co., Limited	Christchurch, N.Z.	50	4996	5 Nov.	91	10 Nov.
New Zealand Dairy Association, Limited, The	Auckland, N.Z.	42	4971	22 Oct.	86	27 Oct.
North British Rubber Company, Limited	Edinburgh, Scotland	38	4828	22 July	95	24 Nov.
Parsons, The Hon. C. A.	Newcastle-on-Tyne, Eng.	6	4985	1 Nov.	91	10 Nov.
Parsons, The Hon. C. A.	Newcastle-on-Tyne, Eng.	13	4986	1 Nov.	95	24 Nov.
Paterson and Co., A. S.	Wellington, N.Z.	42	5079	15 Dec.	..	..
Pike, A. S., and another	Wellington, N.Z.	13	5012	10 Nov.	95	24 Nov.
Pope Manufacturing Company	New York, U.S.A.	22	4525, 6, 7, 9	20 Jan.	83	13 Oct.
Prieto, M.	Manila, Philippine I.	45	4962	18 Oct.	86	27 Oct.
Rogers, A.	Ottawa, Canada	3	5076	14 Dec.	102	22 Dec.
Ross and Glendining, Limited.	Invercargill, N.Z.	38	5042	28 Nov.	98	8 Dec.
Sargood, Son, and Ewen	New Zealand	13	4999	7 Nov.	95	24 Nov.
Sargood, Son, and Ewen	New Zealand	38	5054	1 Dec.	98	8 Dec.
Schlitz Brewing Company, The Jos.	Milwaukee, U.S.A.	43	5077	14 Dec.	..	..
Scott, W. A.	Dunedin, N.Z.	18	4995	4 Nov.	..	..
Scrubb and Co., Limited	London, England	47, 48	5018, 9	14 Nov.	98	8 Dec.
Seidel and Naumann. (See Aktiengesellschaft.)						
Shacklock, Limited, H. E.	Dunedin, N.Z.	18	5016	14 Nov.	95	24 Nov.
Smith and Smith	Dunedin, N.Z.	1	4447	15 Nov. 1903	98	8 Dec.
Sociedad Anonima Germinal Fabrica de Tabaccos. (See M. Prieto.)						
South British Packing Company. (See A. S. Paterson and Co.)						
Southern Cross Biscuit Company, Limited, The	Wanganui, N.Z.	42	5062	8 Dec.	102	22 Dec.
Southern Medical and Manufacturing Company	Christchurch, N.Z.	3	4988	2 Nov.	91	10 Nov.
Spinner and Co., E.	Manchester, Eng., and Bombay, India	24	5084	22 Dec.	3	12 Jan., 1905.
Standard Oil Company of New York	New York, U.S.A.	47	4993	3 Nov.	..	..
Standard Paint Company, The	New York, U.S.A.	50	5047, 8	1 Dec.	6	26 Jan., 1905.
Strange and Company, Limited, W.	Christchurch, N.Z.	38	4980	28 Oct.	95	24 Nov.
Sykes, A. E.	New Plymouth, N.Z.	2	4979	28 Oct.	..	..
Te Rau a Moa Co-operative Dairy Company, Limited	Te Rau a Moa, N.Z.	42	4945	1 Oct.	83	13 Oct.
Thawley, J.	Wellington, N.Z.	42	4954	10 Oct.	91	10 Nov.
Thompson, C. E., and another	Lower Moutere, N.Z.	7	5021	14 Nov.	95	24 Nov.
Tranter, J.	Christchurch, N.Z.	6	4951	6 Oct.	86	27 Oct.
Trevithick, A.	Auckland, N.Z.	43	5038	25 Nov.	98	8 Dec.
Turnbull and Co., W. and G.	Wellington, N.Z.	42	4231	9 June, 1903	98	8 Dec.
Tyree and Co., A.	Christchurch, N.Z.	38	5033	23 Nov.	98	8 Dec.
Ulander, J. J.	Ekon, Sweden	7	5049	1 Dec.	..	..
Victor Butter and Export Box Company Proprietary, Limited	Melbourne, Vic.	50	5074	14 Dec.	..	..

ALPHABETICAL LIST OF APPLICANTS FOR REGISTRATION OF TRADE MARKS—*continued.*

Name.	Address.	Class.	Application.		Gazette.	
			No.	Date.	No.	Date.
Walters and Co. (See R. Middlemas.)						
Walters, H., and another .. ..	Sydney, N.S.W. ..	1	4963	20 Oct. ..	86	27 Oct.
Wendel and Co., I. (See A. Trevithick.)						
Whiley Bros. (See R. and F. Whiley.)						
Whiley, F., and another .. ..	Ohau, N.Z. ..	2	4947	3 Oct. ..	87	13 Oct.
Whiley, R., jun., and another ..	Ohau, N.Z. ..	2	4947	3 Oct. ..	83	13 Oct.
Whitcher, F. W. .. ..	Boston, U.S.A. ..	40	5058	5 Dec. ..	98	8 Dec.
Williams Medicine Company, The Dr. (See G. T. Fulford.)						
Willoughby, A. F. .. ..	London, England ..	3	4964	20 Oct. ..	86	27 Oct.
Wilson, Balk, and Co. .. ..	Dunedin, N.Z. ..	42	5025-7	19 Nov. ..	98	8 Dec.
Wilton, G. W. .. ..	Wellington, N.Z. ..	48	4952	7 Oct. ..	86	27 Oct.
Woodhead, C. H. .. ..	Auckland, N.Z. ..	50	4975	22 Oct. ..	86	27 Oct.
Ziele, C. W. .. ..	St. Albans, N.Z. ..	50	5087	29 Dec. ..	3	12 Jan., 1905.
Zohrab and Co. .. ..	Wellington, N.Z. ..	42	5086	23 Dec. ..	3	12 Jan., 1905.

*List of Applicants for Registration of Designs.*

**A** LPHABETICAL list of applicants for registration of designs for quarter ending 31st December, 1904.

Name.	Address.	No of Class.	Application.		Gazette.	
			No.	Date.	No.	Date.
McTaggart, J., jun. .. ..	Morven, N.Z. ..	1	222	3 Dec. ..	102	22 Dec.
Rodier, G. .. ..	Dunedin, N.Z. ..	2	221	19 Nov. ..	95	24 Nov.



# ILLUSTRATIONS OF INVENTIONS.

[These illustrations refer to the complete specifications accepted, and advertised in this *Gazette*.]

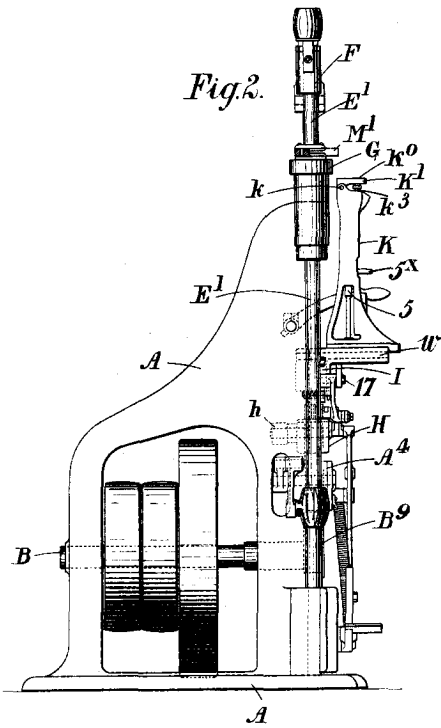

17660  
United Shoe Machinery Company. Heel-attacher. (Bates.)

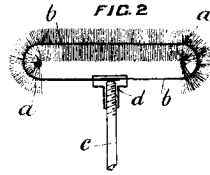

17681  
Roseman. Brush.

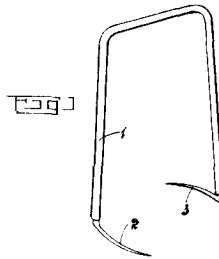

17710  
Warden. Parlour-game Peg.

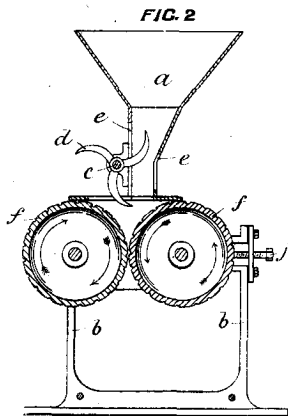

17797  
Hay and Daniel. Treating Offal.



17927  
Dovalosky. Hairpin.

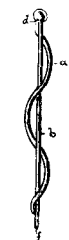

18105  
Dovalosky. Hairpin.

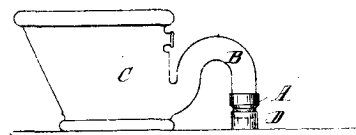

18636  
Denmead and Mahoney. Water-closet Trap.

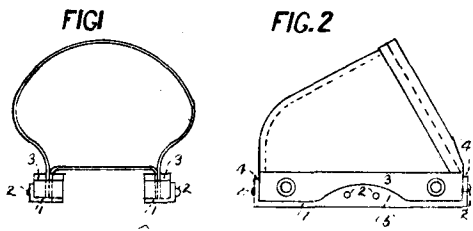

17139  
Douglas. Dredge-bucket Protector.

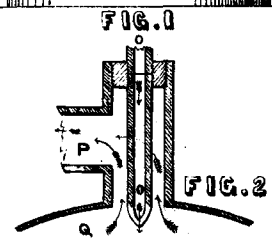
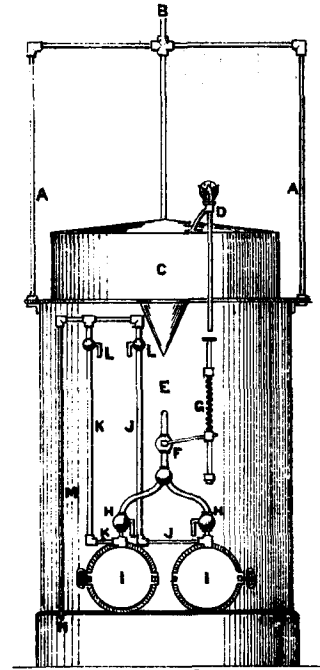

18710  
Murray. Acetylene-generator.

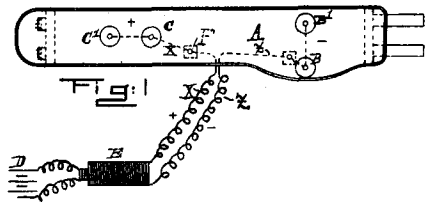

18483  
Dowling and Balfour. Electric Belt.

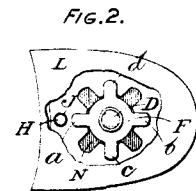

18903  
McCubbin. Boot-heel.

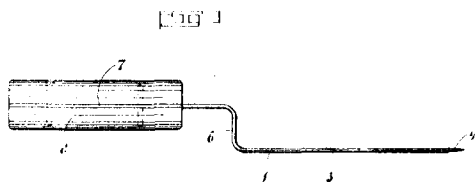

18910  
Lowe. Weeding-knife.

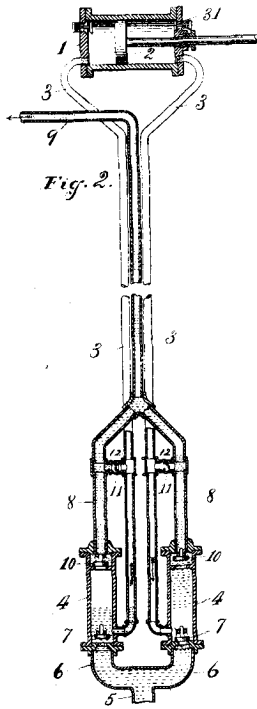

18698  
Starrett. Air-pump.

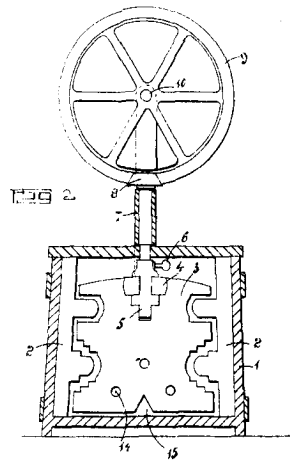

18554  
Baker. Churn.

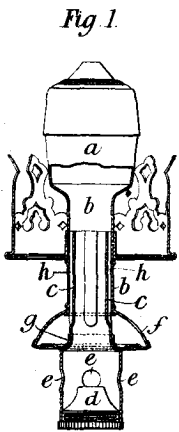

18853  
Alexander. Gas-burner.

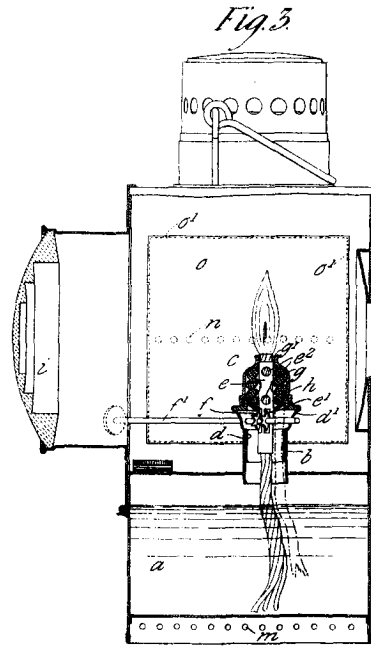

18861  
The Lamp Manufacturing Company (Limited). Signal-lamp.  
(Welch.)

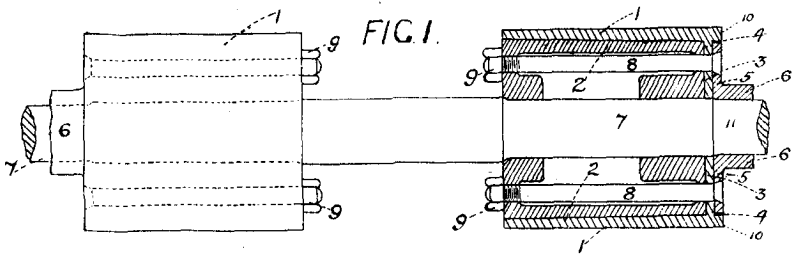

17729  
Douglas. Dredge-roller Protector.

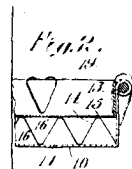

18630  
Phillips. Cream Products. (Taylor.)

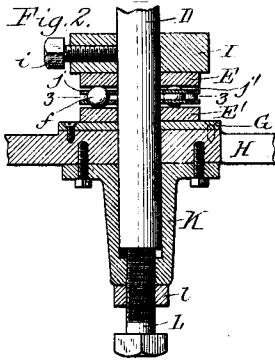

18885  
Smith. Shaft-bearings.

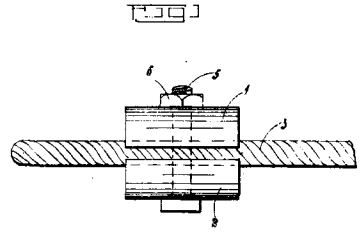

18893  
Gill. Wire-rope Clamp.

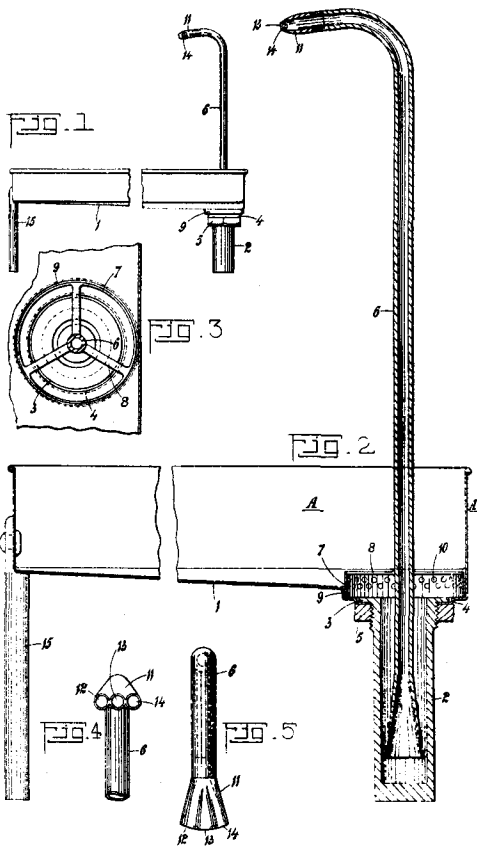

18855  
Williams. Basting-apparatus.

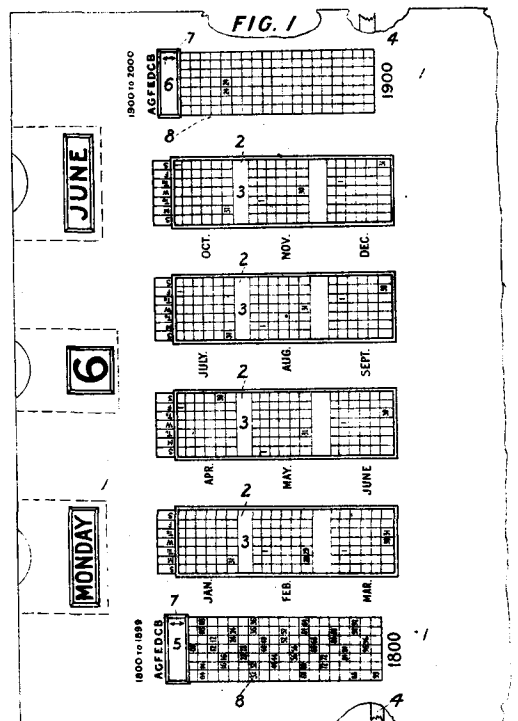

18906  
McLennan. Calendar.